



UNIFI™ MEETING TABLES



UNIFI™ MEETING TABLES

The Salamander Designs Unifi Meeting™ Tables provide the latest in high-quality, customizable solutions so teams can gather quickly and collaborate more easily. Unifi Meeting Table that provide the latest in table solutions to accommodate today's modern offices.

All designs are easy to specify for rapid deployment and offer innovative solutions to support and manage today's technology. Ultra simple to install in just minutes, Unifi is built to last and a future-proof design allows technology updates easily.

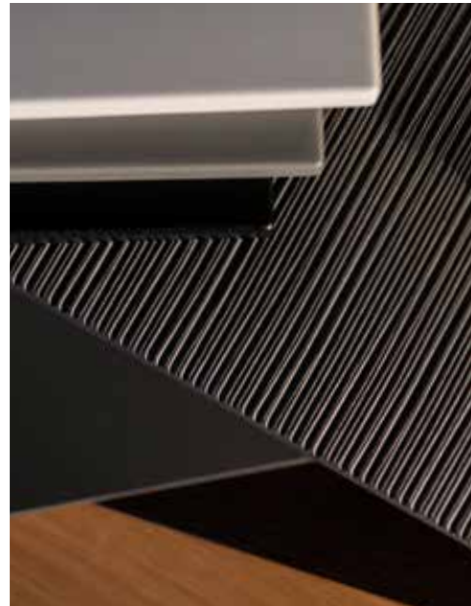

UNIFI HUDDLE™

Ideal for 2 to 5 people seated, Unifi offers select mounting solutions to support virtually any unified communication technology. A premium-grade cabinet features storage for larger AV systems with quick access and easy cable management.

Other thoughtful options include power distribution and cooling systems.



UNIFI HUDDLE™ LITE

Since one size doesn't fit all, the smaller Unifi Huddle Lite accommodates 2 to 3 people at cafe-height and is ideal for a fast-paced environment where people gather often in an impromptu manner. The Unifi Lite is available with or without integrated display mount and features a unique under table storage base is easily accessible for small AV systems.



UNIFI CONFERENCE™

Unifi™ Conference Tables are an award-winning complete series of 6 to 16-ft tables built on an aluminum C-frame design and equipped with an innovative pedestal that allows virtually all wiring, power supplies, A/V components and cables to be hidden yet easily accessible in lift off panels for servicing.



UNIFI™ CONFERENCE

4-16 PERSON

Charge and Connect

- Top surface cable cubby and connections
- Under surface charging ports
- Pedestal located power ports
- Custom cut-in of any customer supplied device

Low Impact Installation
Easy to deploy, simple to move

Large Open Table Storage Pedestal

- Built on aluminum chassis
- Lift off access panel on both sides of storage base allow simple equipment access
- Cable management from floor to pedestal with fully open interior and raceway up to table
- Equipment storage options include rack mount equipment with 3ru vertical racks and cooling systems
- Ample space to accommodate large cable retractor systems
- Vented pedestal provides convection cooling

Storage Pedestal

A variety of laminate and real wood veneer finishes with black legs and toe-kick.



White, Laminate



Siena, Black Oak Wood



Siena, Gray Walnut Wood



Siena, Medium Walnut Wood



Siena, Wengé Oak Wood



Siena, American Cherry



Siena, Natural Oak Wood

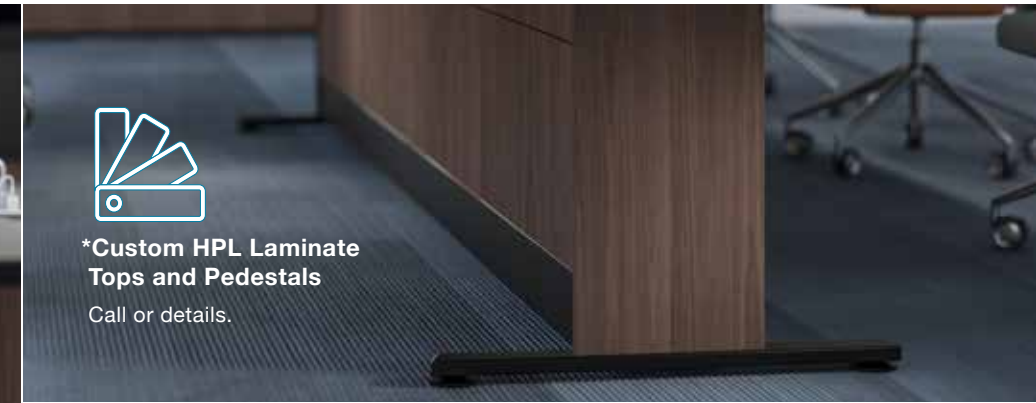

***Custom HPL Laminate
Tops and Pedestals**
Call for details.

Shapes & Sizes

Rectangular, Trapezoid or boat shapes in two table width (4' and 5') and up to 6 lengths (6', 8', 10', 12', 14' and 16'). Split top option available for easy transportation and assembly.

Shape	4'x16'	4'x14'	4'x12'	4'x10'	4'x8'	4'x6'
Rectangular	5'x16'	5'x14'	5'x12'	5'x10'	5'x8'	5'x6'
	14-16 seats	12-14 seats	10-12 seats	8-10 seats	6-8 seats	4-6 seats
Trapezoid	5'x16'	5'x14'	5'x12'	5'x10'	5'x8'	5'x6'
	13 seats	11 seats	9 seats	7 seats	5 seats	3 seats
Boat	4'x16'	4'x14'	4'x12'	4'x10'	4'x8'	4'x6'
	5'x16'	5'x14'	5'x12'	5'x10'	5'x8'	5'x6'
	14-16 seats	12-14 seats	10-12 seats	8-10 seats	6-8 seats	

Table Surfaces

Square, Plywood Edge

Matching, Knife Edge

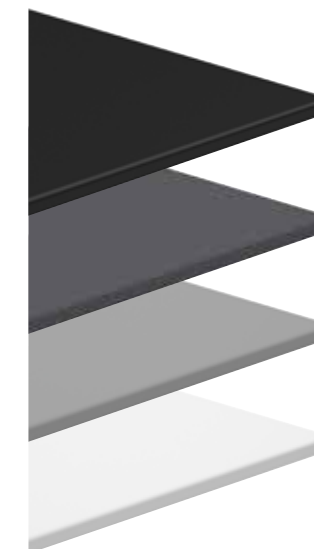
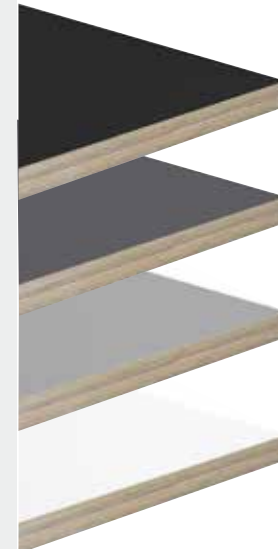

Table Edges

Wilsonart® Traceless™ Ultra Matte Laminates

Super durable table top surface, with a soft-to-the-touch super matte, unique fingerprint-resistant, technology that ensures smears, smudges and streaks are seldom seen.



Wilsonart® Satin High Pressure Laminates

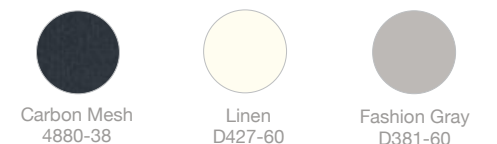

UNIFI™ HUDDLE

2-5 PERSON



Displays

Single, dual or no display mount options.

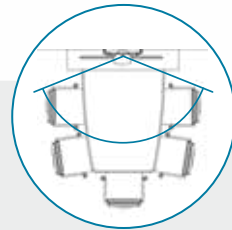

Boat Shape Table

Optimized to provide ideal camera field of view

Huddle Tops & Edges

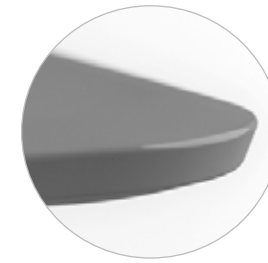

Butter-knife Edge
3/4" Seamless
Powder-Coated MDF

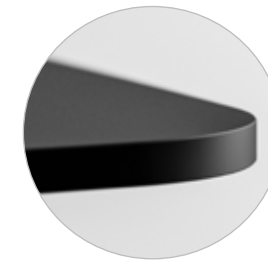

Square Edge
1/2" Solid Black (Only)
Compact Core

Solid Black
Solid Black
Compact Core*

Slate Gray
Seamless

Warm White
Seamless

*Custom HPL
Laminates Available
Call or details.



Table: 60" (L) x 48" (W) x 29" (H)

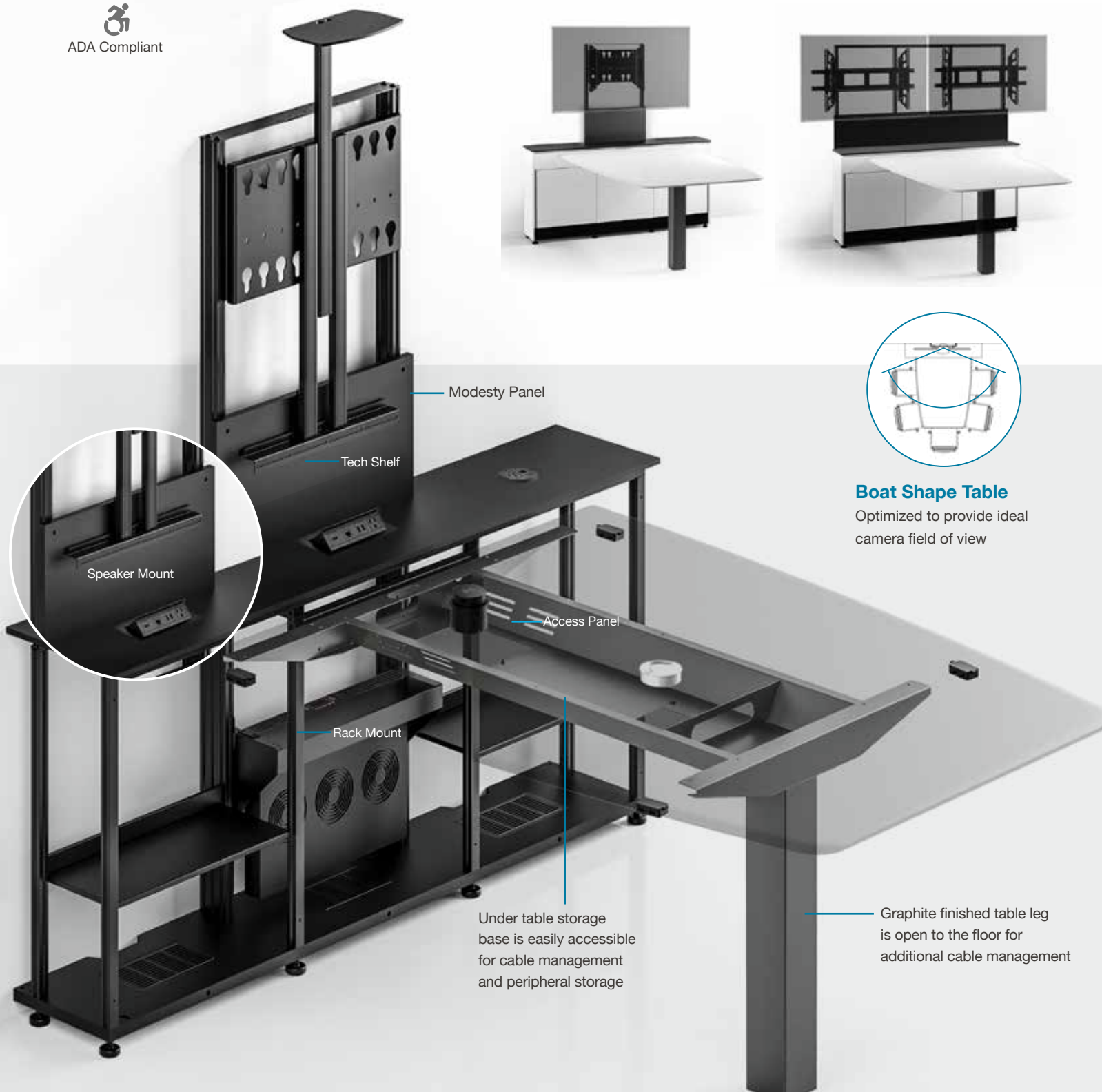

Modesty Panel

Tech Shelf

Speaker Mount

Access Panel

Rack Mount

Under table storage base is easily accessible for cable management and peripheral storage

Graphite finished table leg is open to the floor for additional cable management

Low Impact Installation
Easy to deploy, simple to move

Aluminum Chassis Cabinet
Includes 3RU vertical rack and adjustable tray shelves

Wire Management
Throughout open cabinet, back with fully open interior and raceway up to display and to table



Huddle Storage Cabinet

A variety of laminate and real wood veneer finishes with black cabinet top.



Warm, White Gloss



Slate, Gray, Matte



Siena, Black Oak Wood



Siena, Natural Oak Wood



Siena, Wengé Oak Wood

Cabinet Measures: 65" (W) x 31" (H) x 12" (D)

UNIFI™ HUDDLE LITE

2-5 PERSON

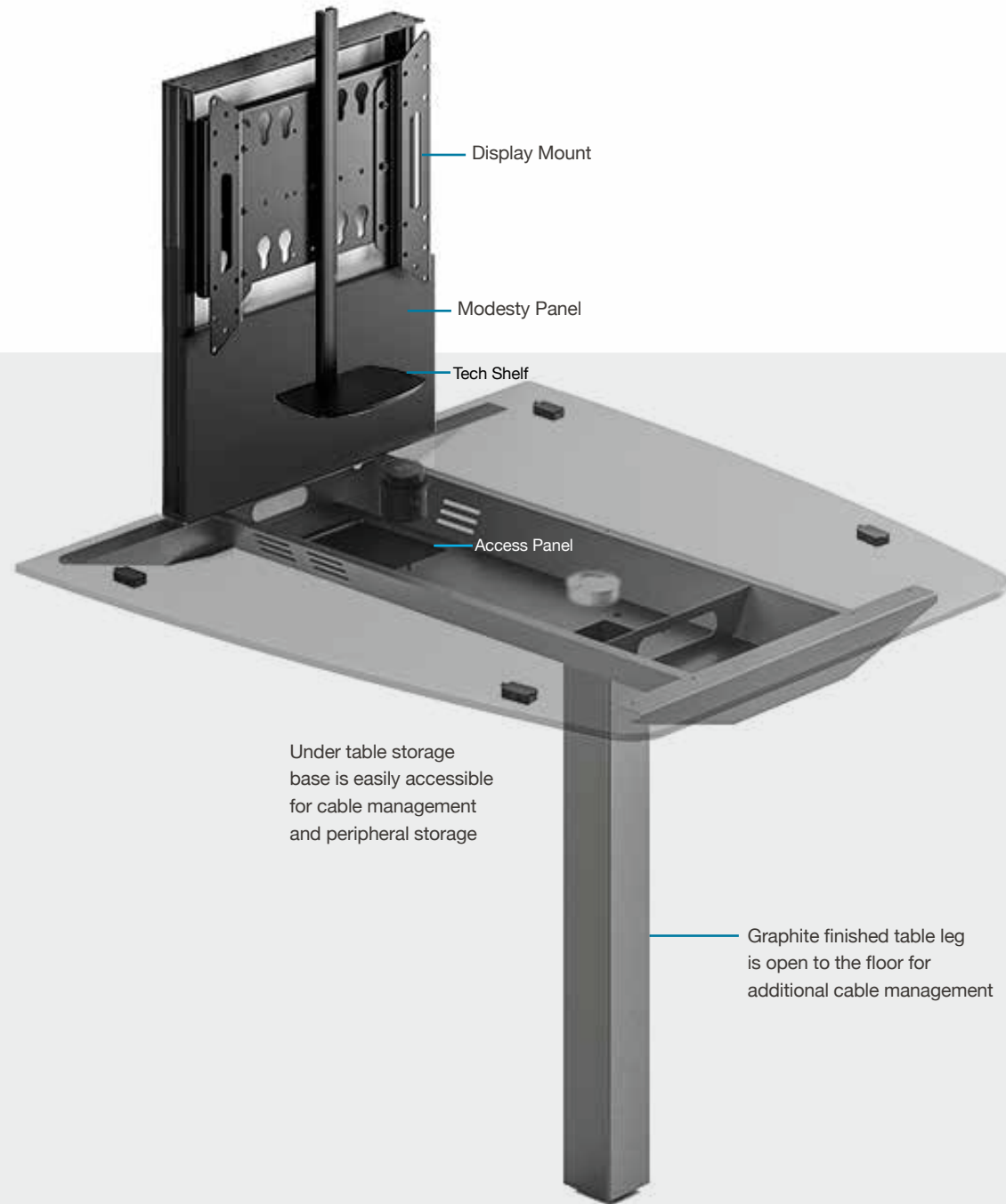

Under table storage base is easily accessible for cable management and peripheral storage

Graphite finished table leg is open to the floor for additional cable management

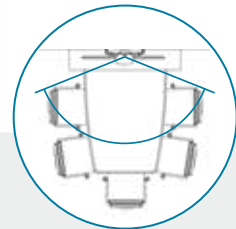

Boat Shape Table
Optimized to provide ideal camera field of view



Low Impact Installation
Easy to deploy, simple to move



Wire Management
Throughout fully open interior and raceway up to display

Huddle Lite Heights

Select standard or cafe height.



Cafe Table: 48" (L) x 48" (W) x 39" (H)
60" (L) x 48" (W) x 39" (H)

Standard Table: 48" (L) x 48" (W) x 29" (H)
60" (L) x 48" (W) x 29" (H)

Huddle Lite Tops & Edges

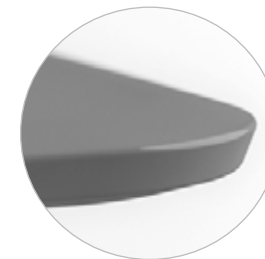

Butter-knife Edge
3/4" Seamless
Powder-Coated MDF



Square Edge
1/2" Solid Black (Only)
Compact Core



Solid Black
Solid Black

Slate Gray
Seamless

Warm White
Seamless

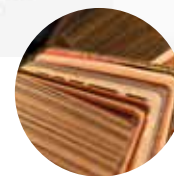

***Custom HPL Laminates Available**
Call or details.



UNIFI™ HUDDLE

Siena style in your choice of finishes with black cabinet top.

2-5 PERSON



Cabinet Finishes	Single Display	Dual Display	No Display	4'x5' Table Top
Warm White Gloss (Laminate)	D1/338AM1/SN/GW/BK	D1/338AM2/SN/GW/BK	D1/338A/SN/GW/BK	Warm White 3/4" Seamless TP4860A/S/WW
Slate Gray Matte (Laminate)	D1/338AM1/SN/SG/BK	D1/338AM2/SN/SG/BK	D1/338A/SN/SG/BK	Slate Gray 3/4" Seamless TP4860A/S/SG
Gray Oak (Veneer)	D1/338AM1/SN/GO/BK	D1/338AM2/SN/GO/BK	D1/338A/SN/GO/BK	Solid Black 1/2" Solid Black Compact Core* TP4860A/C/BK1
Black Oak (Veneer)	D1/338AM1/SN/BO/BK	D1/338AM2/SN/BO/BK	D1/338A/SN/BO/BK	
Wengé Oak (Veneer)	D1/338AM1/SN/WO/BK	D1/338AM2/SN/WO/BK	D1/338A/SN/WO/BK	
Natural Oak (Veneer)	D1/338AM1/SN/NO/BK	D1/338AM2/SN/NO/BK	D1/338A/SN/NO/BK	

Cabinet: 65" (W) x 31" (H) x 12" (D)

Table: 60" (L) x 48" (W) x 29" (H)

UNIFI™ HUDDLE LITE

2-3 PERSON



Warm White 3/4" Seamless	UHL40AM1/G/S/WW	UHL40A/G/S/WW	UHL30AM1/G/S/WW	UHL30A/G/S/WW
Slate Gray 3/4" Seamless	UHL40AM1/G/S/SG	UHL40A/G/S/SG	UHL30AM1/G/S/SG	UHL30A/G/S/SG
Solid Black 1/2" Solid Black Compact Core*	UHL40AM1/G/S/BK1	UHL40A/G/S/BK1	UHL30AM1/G/S/BK1	UHL30A/G/S/BK1

Cafe Table: 48" (L) x 48" (W) x 39" (H)
60" (L) x 48" (W) x 39" (H)

Standard: 48" (L) x 48" (W) x 30" (H)
60" (L) x 48" (W) x 30" (H)

Customize Your Unifi™ Huddle Table

with optional cut-ins and interior accessories for a complete turnkey video conference solution.



HUDDLE TABLE VIDEO CONFERENCE



Speaker/Camera Mount

Speaker sold separately



Tech Shelf

Camera sold separately



CONNECTION PORTS

Ports can be placed in various locations throughout table and cabinet. Reference page 14 for location specs.



Flush Mount 110v Power and Dual USB Charge

#FI/CP5/BK – Black



Pop-up Wireless Qi Charger with Triple USB Charging

#FI/CP4/BK – Black



Cable Port

#FI/CP2/BK – Black
#FI/CP2/SN – Satin Nickel



Under Table Dual USB Charging Dock

#FI/CP8/BK – Black



Popup Charge & Connect

#FI/CP7/BK – Black



Pen Holder

#FI/CP6/BK – Black
#FI/CP6/SA – Satin Aluminum



CABINET INTERIORS



Vertical Rack Mount

#FI/RM/VR/3U
#FI/RM/VR/5U



1RU Vertical, Rack Mounted Cooling Kit

#FI/SA/IUAC



1RU Multi-Port Rack Mounted Power Distribution Unit

#FI/RM/PDU

Customize Your Unifi™ Conference Table

with optional cut-ins and interior accessories for a complete turnkey video conference solution.



CONNECTION PORTS

Ports can be placed in various locations throughout table and cabinet. Reference page 7 for location specs.



Flip-Top Charge & Connect
#FI/CP9/SA – Silver Aluminum



16x6 Cable Cubby
#FI/CP10/SA – Silver Aluminum



CABINET INTERIORS

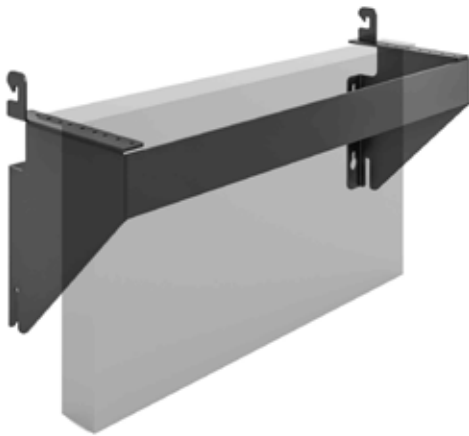

Vertical Rack Mount
#FI/RM/VR/3U
#FI/RM/VR/5U



1RU Vertical, Rack Mounted Cooling Kit
#FI/SA/IUAC



1RU Multi-Port Rack Mounted Power Distribution Unit
#FI/RM/PDU



Specify Your Own Device with a Custom Cut-In

Specifications

VIDEO CONFERENCE

Display Mounts

Select Table Model

- Universal single or dual display mount with adjustable positions
- Holds displays up to:
 - Huddle: 175 lbs (80 kg)
 - Huddle Light: 110 lbs (50 kg)
- Single: VESA 200 x 200 – 400 x 600
- Dual: VESA 200 x 200 – 400 x 600
- Adjustable Center Line of Screen: 60"/58"/56"/54"

Speaker/Camera Mount

#FI/SBK

- Fully adjustable height
- Mount above or below display
- Accommodates most video/audio conference systems
- Universal mounting plate pattern: 0-16"
- Max weight capacity of 25 lbs (11 kgs)

Tech Shelf

#FI/CMS/S – Single Shelf

#FI/CM/D – Dual Shelf

Call for Custom Sizes

- Camera, Speaker, and Controller Shelf
- Fully adjustable height
- Mount above or below display
- Max weight capacity of 5 lbs (2 kgs)
- Single Shelf: 7" (W) x 5.75" (D) x .25" (Th)
- Dual Shelf: 26.25" (W) x 6.75" (D) x .5" (Th)

CABINET INTERIORS

Vertical Rack Mounts

#FI/RM/VR/3U – 3RU

#FI/RM/VR/5U – 5RU

- 3 and 5 rack units of vertical mounted, knob up component storage (total 15RU)
- Threaded for 10-32 screws
- Black powder coated steel
- Lift and load design for easy install
- 10-32 threaded fasteners

1RU Vertical, Rack Mounted Cooling Kit

#FI/SA/IUAC – Black

- Airflow: 40 to 180 CFM | Noise: 9 to 32 dBA
- 180 cfm of airflow at max efficiency maintains a 20 degree rise of up to 3750 BTU of electronics
- 19" (W) x 13.5" (D) x 1.75" (Th)
- Probe Length: 72"
- Power Consumption: 8 W, 0.67 A
- Power In: 100 to 240V AC
- 6' Power Cord
- RoHS and CE Certified
- UL Listed

1RU Multi-Port Rack Mounted Power Distribution Unit

#FI/RM/PDU – Black

- 8 Rear Ports, 1 Front Port
- Maximum Output Current: 15 Amps
- Spike Protection Mode: Line to neutral
- Energy Dissipation: 170 Joules
- Peak Impulse Current: 12,000 Amps
- Maximum Continuous Operating Voltage: 130 VAC RMS
- 9" (W) x 3.75" (D) x 1.75" (Th)
- Safety Agency Listing: cTUVus Certified
- 6' Cord

CONNECTION PORTS SPECS & CUT-IN LOCATIONS

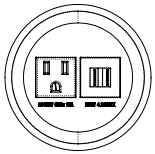

3" Round Flush mount 110v Power and Dual USB Charge

#FI/CP5/BK – Black

- 1 Outlet, AC 125V 15A max
- 5V 4.2A USB module with 2 ports
- Bore 3" hole for installation
- 10' SJT 14 AWG*3C power cord
- UL Certified
- Cut-In Locations 1, 2, 3, 5, 6



Pop-up Wireless Qi Charger with Triple USB Charging

#FI/CP4/BK – Black

- Power Input: DC 5V, 6A max
- Wireless Charger: 5 watts max
- USB Charger: 1 x 2.4A (12 watts) max and 2 x 1A (5 Watts) Max
- Wireless Charging Distance: 6mm max
- Qi V1.2.4 Certified
- UL, cUL, FCC ID, RoHS Certified
- Cut-In Locations 1, 2, 3, 4, 5, 6

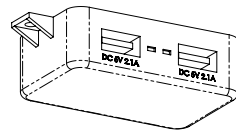

Under Table Dual USB Charging Dock

#FI/CP8/BK – Black

- Dual 5V DC 2.1A (10.5 Watts) USB charging ports
- Input 5VDC 4.2A wall plug adapter with 8' lead
- Blue LED back-lighting
- Cut-In Locations 7A, 7B, 7C, 7D

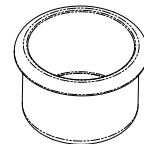

3-3/4" Round Pen Holder

#FI/CP6/BK – Black

#FI/CP6/SA – Satin Aluminum

- Cut-In Locations 1, 2, 3, 4, 5, 6

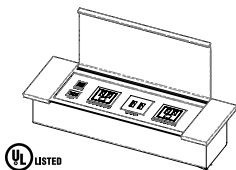

Flip-Top Charge & Connect

#FI/CP9/BK

- Satin Aluminum Cover Opens Fully Flat
- Integrated Socket 4 Module 11x 4"
- 3 Grounded AC Outlets, 110 V
- 6' Cord
- 2 USB Charging
- 1 CAT6
- 1 HDMI coupler
- Cut-In Locations 1, 2, 3, 4
- UL Listed

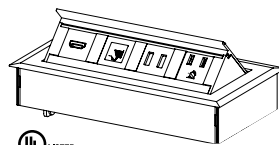

4x6 Popup Charge & Connect

#FI/CP7/BK

- Aluminum Housing
- 1 Grounded AC Outlet, 125 V 12A rating
- 5V 4.2A USB module with 2 ports
- 1 HDMI coupler
- 1 Ethernet RJ45 Coupler power cord
- UL Certified
- Cut-In Locations 1, 2, 3
- 10' Power Cord

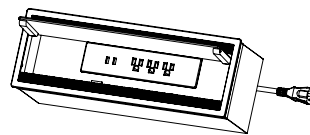

16x6 Cable Cubby

#FI/CP10/SA – Satin Aluminum

- Finely finished Aluminum cover
- Wire brushes allow cover to close while cables are in use
- 3 Grounded AC Outlets
- 6' Power Cord
- 2 USB Charging
- 1 CAT6
- 1 HDMI coupler
- Cut-In Locations 1, 2, 3

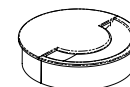

3-3/8" Round Cable Port

#FI/CP2/BK – Black

#FI/CP2/SN – Satin Nickel

- Split Body Design for Plug and Wire Pass Through
- Cut-In Locations 1, 2, 3, 4, 5, 6

Unifi Huddle Cut-In Locations

UNIFI HUDDLE

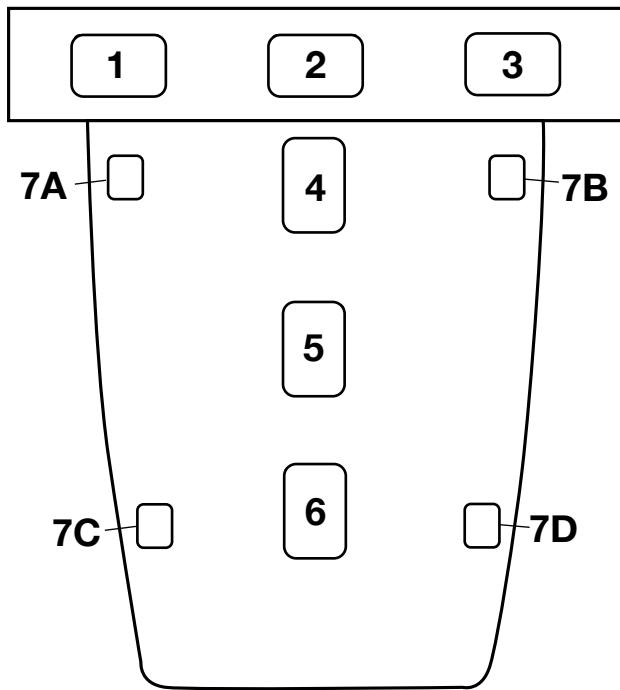

UNIFI HUDDLE LITE

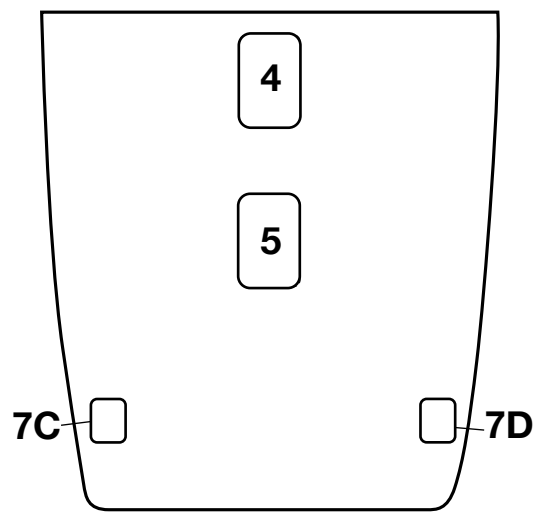

Unifi Conference Cut-In Locations

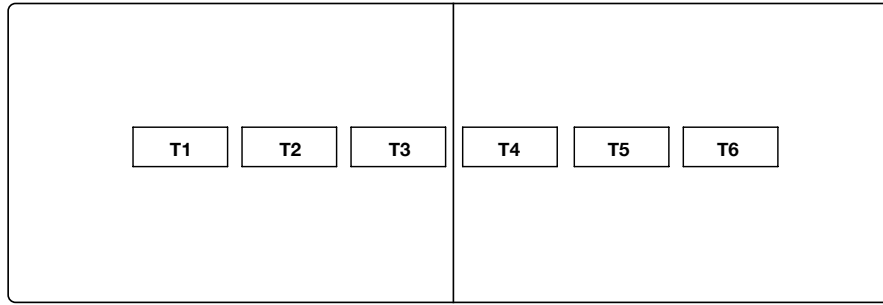

4 x 16 ft

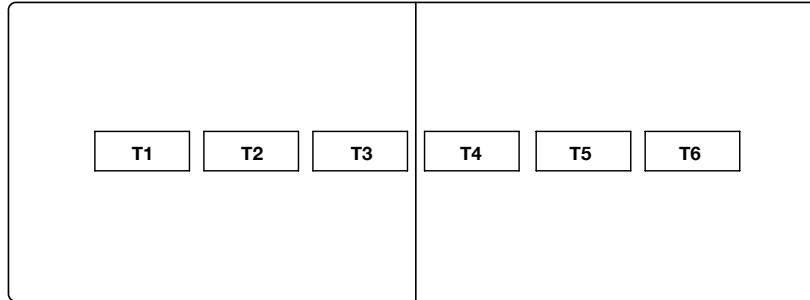

4 x 14 ft

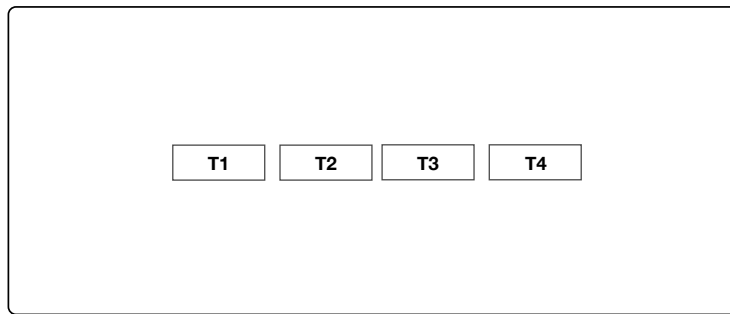

4 x 12 ft

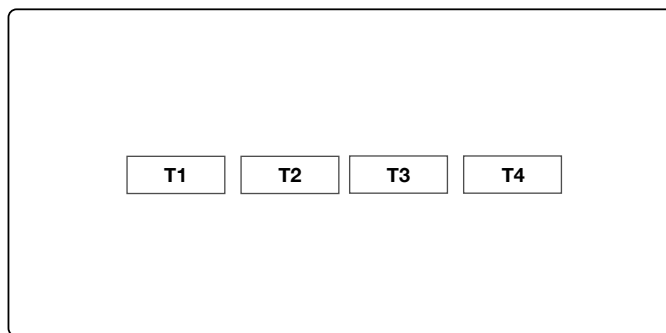

4 x 10 ft

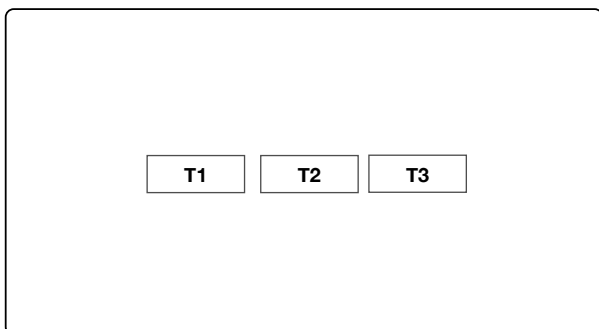

4 x 8 ft

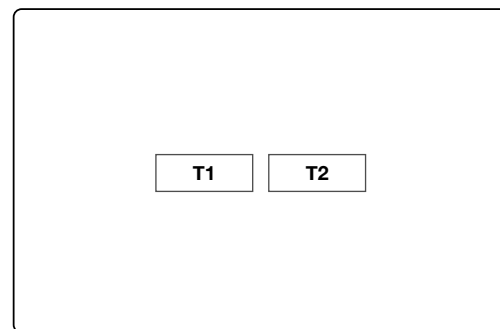

4 x 6 ft

CUSTOM MADE EASY

Salamander specializes in custom designing and manufacturing high-performing furniture solutions for complex projects.

Call us for a free design consultation.



SALAMANDER DESIGNS
811 Blue Hills Avenue
Bloomfield, CT 06002

salamandercommercial.com
custom@salamanderdesigns.com
800.535.9910



Salamander technology partners provide solutions that, when integrated with the Unifi Tables, create the perfect interactive, collaboration solutions for every corporate environment.

