

IDEAL FOR UNEVEN SURFACES

BT8380-AFB

BOLT DOWN FLOOR BASE WITH LEVEL ADJUSTMENT

Designed to securely fix B-Tech's vertical columns, poles or rails to uneven floors, the BT8380-AFB uses a levelling plate with +/-13.5mm of adjustment available on each corner ensuring a level installation of the display stand. The bolt down floor base is suitable for use on floors with minor slopes or uneven surfaces and strong enough to support substantial loads of up to 150kg per column. With a minimal footprint, the BT8380-AFB is ideal for installations where floor space is limited, such as corporate locations, control rooms, retail shop fronts or for close to the wall displays.

SPECIFICATION

Max load	150kg per base*
Base dimensions	W: 183mm D: 213mm H: 45mm
Adjustment	+/- 13.5mm in each corner
Bases supplied per pack	1
Colour	Black

**No more than 100kg should be mounted at a height above 1.2m on BT8380 columns*

FEATURES

- Level adjustment suitable for use on uneven floors
- Small footprint is ideal for retail and corporate applications where floor space is limited
- Heavy duty steel capable of supporting substantial loads
- Can be used for large scale DVLED or videowall installations in straight or curved configurations - ideal for applications such as control rooms
- Integrated cable management
- Compatible with a variety of B-Tech columns (BT8380 / BT8381 / BT8385), poles (BT4116 / BT4118) and rails (BT8390)
- TUV certified



SYSTEM X™



Level adjustment screws for adjusting the base on an uneven surface



Can be used for single column installations in landscape or portrait format



Easy installation with directional arrows and simple level adjustment

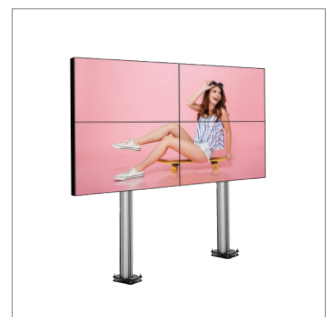

Can be used for large scale straight or curved installations - ideal for control rooms

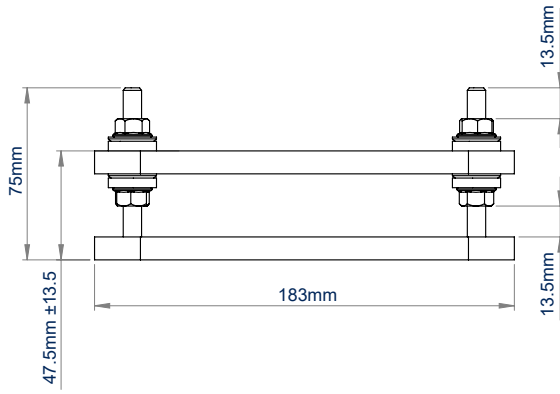

FRONT VIEW

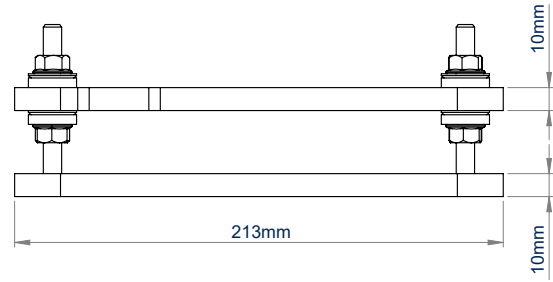

SIDE VIEW

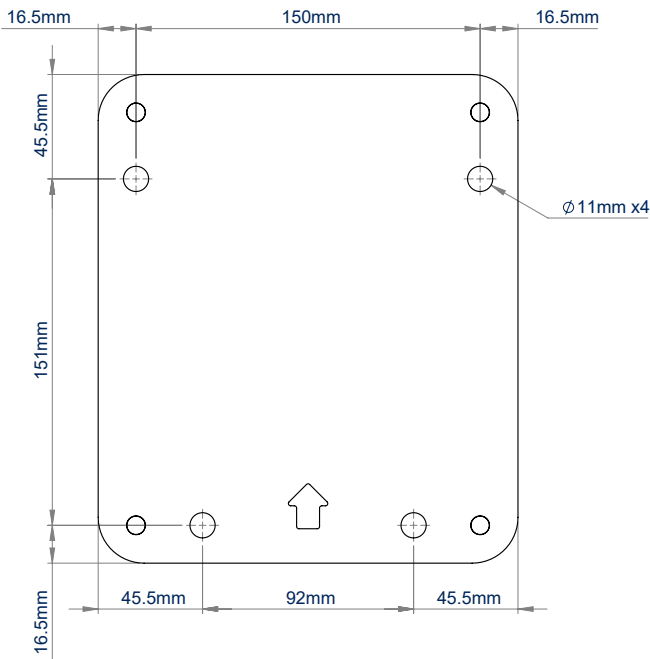

BOTTOM VIEW

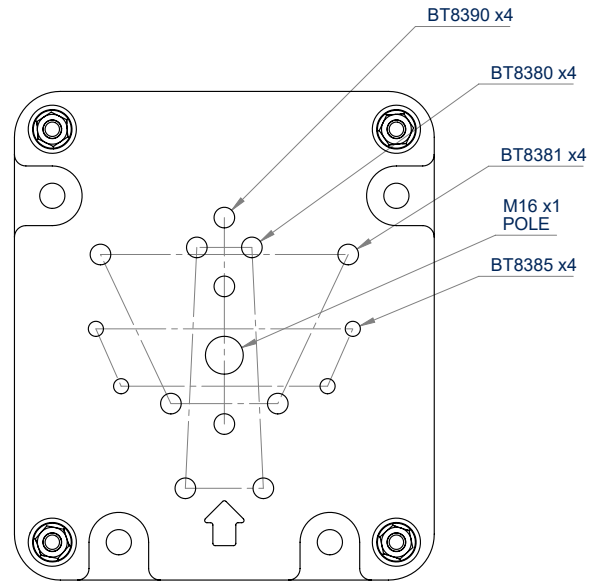





TOP VIEW

PACKING INFORMATION

COLOUR:	ORDER REF:	EAN CODE:
Black	BT8380-AFB/B	5019318305924

ACCESSORIES AND RELATED PRODUCTS

<p>BT8380-060/180</p> 	<p>BT8385</p> 	<p>BT8380-FFB</p> 	<p>BT8380-FFT</p> 
<p>Vertical Support Columns for freestanding, mobile or bolt-down screen mounting</p>	<p>Vertical Support Columns capable of supporting single or multiple horizontal mounting rails</p>	<p>Bolt Down Floor Base securely fixes system X installations to the floor</p>	<p>False Floor Trim use with BT8380 columns installed with false floors</p>

© 2018 B-Tech International Pty Ltd. All rights reserved.
 The information in this specification is intended as a guide only. B-Tech International Pty Ltd. is not responsible for any damage or injury caused by improper or unsafe use of its products. Any reproduction or transmission of any part of this specification is expressly prohibited unless prior written permission has been granted by B-Tech International Pty Ltd. (B-Tech).
 SS-V2.1-BT8380-AFB-041023