

BT9909

SYSTEM X POP-OUT ULTRA-STRETCH SIGNAGE MOUNT FOR LG 86BH5C

The BT9909 is a pop-out mounting solution that is ideal for portrait mounting LG's 86BH5C Ultra-Stretch Signage in a recessed wall. Tool-less, micro-adjustment allows mounted screens to sit perfectly flush with the wall and the pop-out mechanism provides access to the rear of the screen for easy installation and maintenance. Safety screws come as standard to help prevent unauthorized removal of the screen and height adjustment screws allow the screen to be leveled perfectly after installation.

SPECIFICATIONS

Recommended screen size	86"
Max load	110lbs
Max VESA® fixings	600 x 200
Depth (flat)	4.33" (+/-0.39" with micro-adjustment)
Depth (popped out)	10.98" (+/-0.39" with micro-adjustment)
Screen height adjustment	+/-0.78"
Color (horizontal rail)	Black
Color (interface arms)	Black

FEATURES

- 1 Ideal for mounting a screen in a recess
- 2 Tool-less micro-adjustment for seamless display alignment
- 3 Pole mounted version for ceiling and floor mounting is available on request
- 4 Arms include locking screw to prevent accidental pop-out of screens
 - Arms feature leveling screws to adjust the screen height
 - Pop-in, pop-out function allow access to the rear of screens for servicing
 - Safety screws help prevent unauthorized removal of screens
 - High-end aesthetic quality with stylish end caps for a neat and tidy install
 - All mounting hardware included



RECOMMENDED MAX SCREEN	MAX LOAD	MAX VESA	MICRO ADJUSTMENT	POST INSTALL ALIGNMENT	COMPATIBLE WITH SYSTEM X	QR CODE
86" 218cm	110lbs	600 x 200				

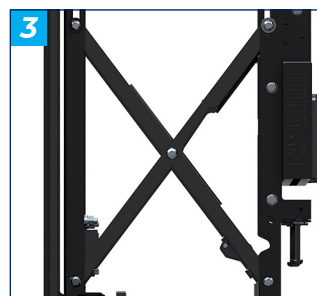
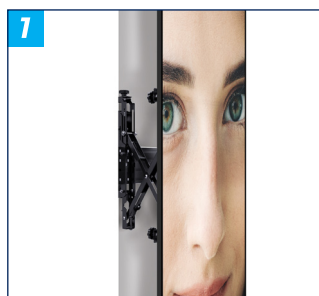

BT9906

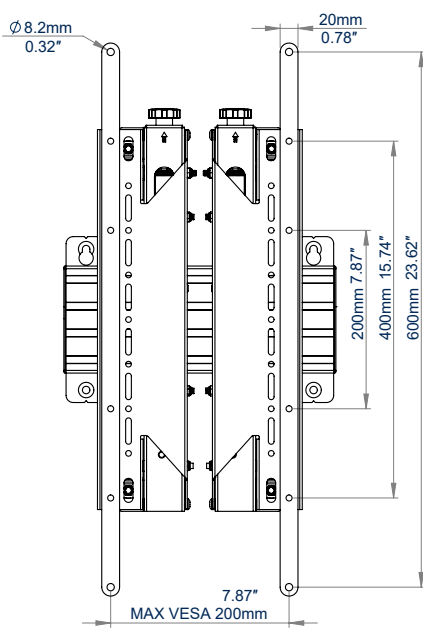

FRONT VIEW

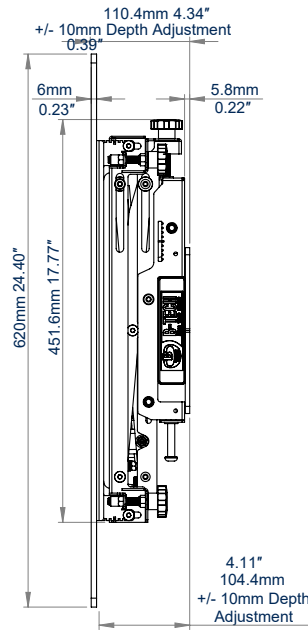

**SIDE VIEW
CLOSED**

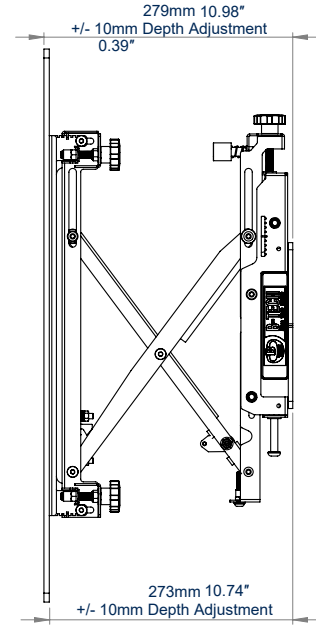

**SIDE VIEW
EXTENDED**

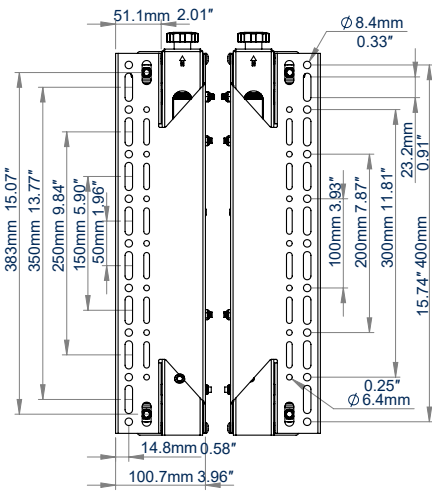

INTERFACE ARMS

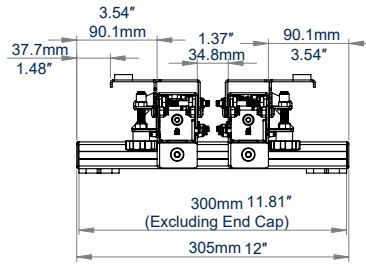

TOP VIEW

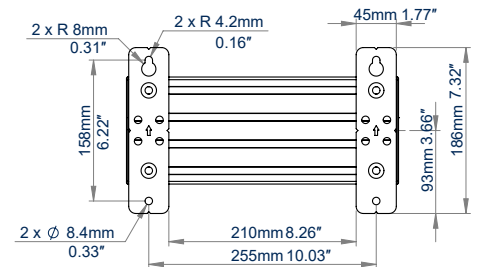

WALL PLATES AND RAIL

ORDERING INFORMATION

COLOR	ORDER REF	UPC
Black	BT9909/BS	811867037784

RELATED PRODUCTS

PRODUCT CODE	NAME	DESCRIPTION
BT9905	Ultra-Stretch Signage Mount	For use when landscape mounting
BT9906	Ultra-Stretch Signage Mount	For use when portrait mounting
BT7822	Heavy Duty Ceiling Mount	Use with System 2 poles and collars to create ceiling mounted solutions
BT7850	Ø2" Poles	Available in 5 different lengths; 19.68", 39.37", 59.05", 78.74" and 118.11"

© 2015 B Tech AV Mounts, Co., Ltd. All rights reserved.
 The information this specification sheet reflects the current technical specifications at the time of printing.
 We reserve the right to change the technical or physical specifications without prior notice. This B Tech name and the B Tech logo are registered trademarks of B Tech AV Mounts Co., Ltd.
 B Tech is not responsible for loss or damage caused by improper installation or mounting on unstable structures. Any reproduction or use without our prior written permission is strictly prohibited. Customer permission is granted by B Tech AV Mounts Co., Ltd. to use the B Tech logo on their website.
 SS-BT9909-150424-NA