

ADA Rail System One

ADA compliant detectable barrier that solves protrusion issues caused by wall mounted video displays. Modular system designed for displays 55-86" with durable, long lasting, brushed stainless steel finish. Easy to install to wall, no floor drilling required.

ADA RAIL MODEL	DISPLAY SIZE DIAGONAL	MAX DISPLAY WIDTH FOR ALLOWABLE ADA OVERHANG
AR1/48/SS	43"	56"
	49"	
	55"	
AR1/60/SS	65"	68"
	75"	
AR1/72/SS	85"	80"
	86"	
	DUAL 43"	
AR1/84/SS	98"	92"
	DUAL 49"	
AR1/108/SS	DUAL 55"	116"
	DUAL 65"	

LENGTH

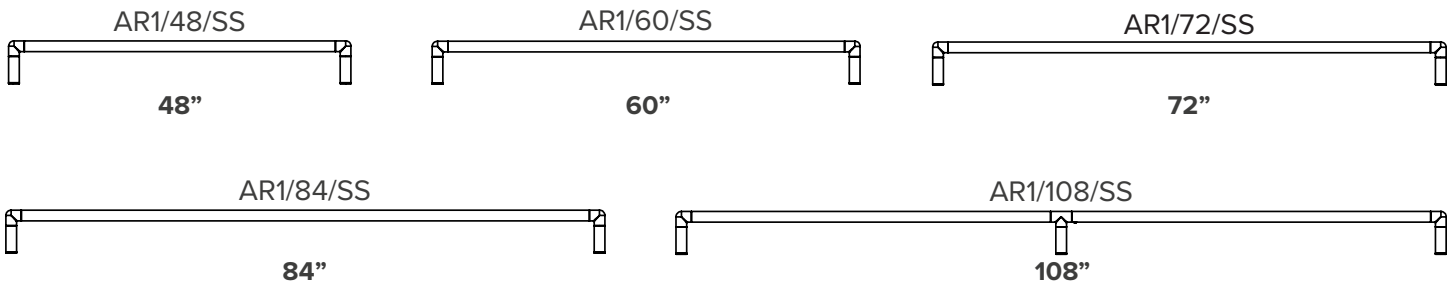

HEIGHT & DEPTH

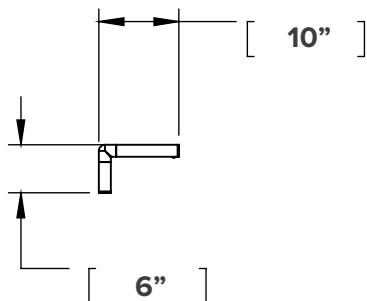

FINISH

316 Stainless Steel, Brushed Finish

Note: Max Allowable Display protrusion from Wall is 14" with Rail System



8 7 6 5 4 3 2 1

D

D

C

C

B

B

A

A

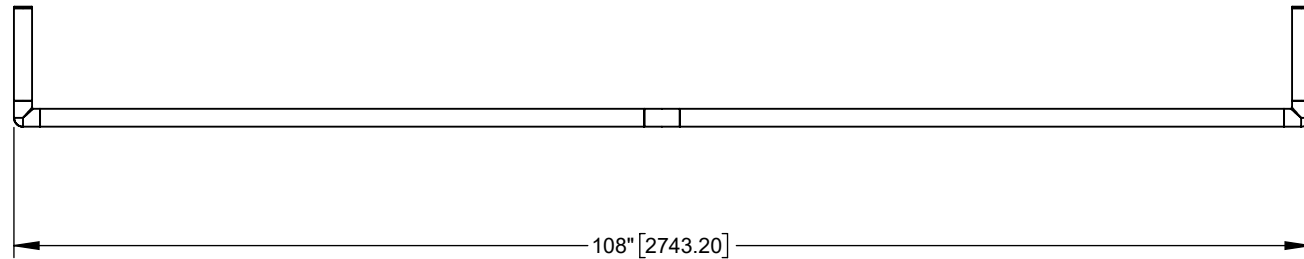

Mounts to Wall

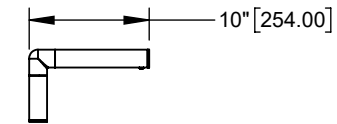
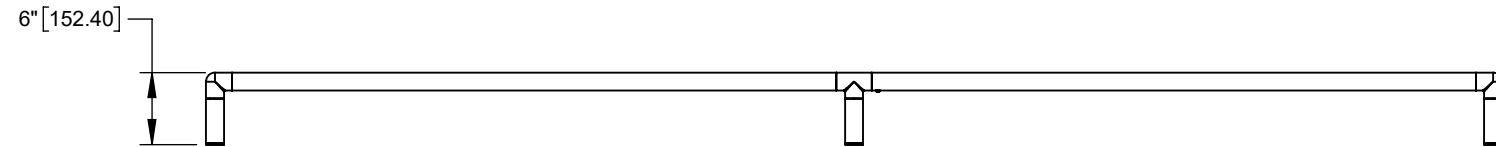
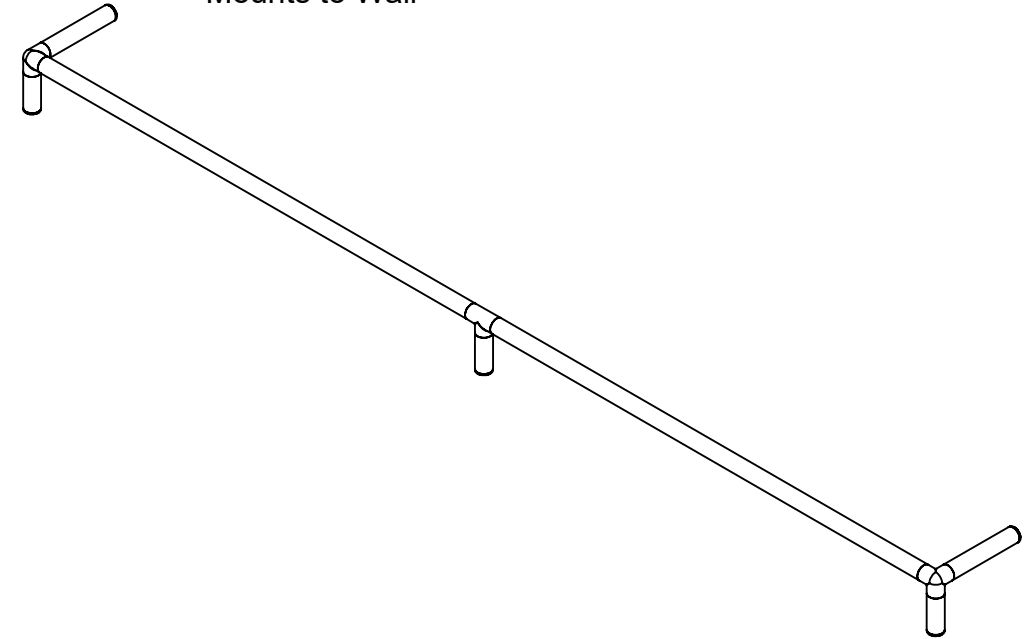

ADA Rail System
108" Detectable Barrier
Dual 55, Dual 65 Inch Displays

Material:
Stainless Steel Tubing, 316 Satin SS, 1.5" OD, 0.06" Wall

UNLESS OTHERWISE SPECIFIED:

- ALL THREADS TO BE CLASS 2
- COUNTERSINK ALL TAPPED HOLES
- DEBURR HOLES AND BREAK SHARP EDGES
- STAMP, ETCH, OR MARK DRAWING NUMBER AND REVISION LETTER ON A NON-CRITICAL SURFACE.
- SURFACE FINISH TO BE 63 RMS
- TOLERANCES: X ± .1
- .XX ± .01
- .XXX ± .005
- .XXXX ± .0005
- X° ± 1°
- .X° ± .5°



3rd ANGLE PROJECTION

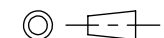

	811 BLUE HILLS AVE. BLOOMFIELD, CT 06002 T/ 860.313.0525 / F/ 860.313.0526		SIZE B
	TITLE: ADA Rail System One, 108" (9') Front Rail, Satin Stainless		

QTY

NEXT ASSEMBLY

APPLICATION

PROPRIETARY INFORMATION: THIS MATERIAL AND THE CONTENTS THEREOF ARE CONSIDERED THE PROPERTY OF SALAMANDER DESIGNS, AND THE DISCLOSURE TO UNAUTHORIZED INDIVIDUALS OR DISSEMINATION, PUBLICATION, OR COPYING THEREOF IS PROHIBITED WITHOUT PRIOR WRITTEN CONSENT BY SALAMANDER DESIGNS OF BLOOMFIELD, CONNECTICUT.

MATERIAL: **SEE NOTE**

DRAWN BY: _____ DATE: _____ HEAT TREATMENT: _____

ENGINEER: _____ CHECKED BY: _____ SCALE: 1:16 SHEET: 1 OF 5

DRAWING NUMBER: **AR1/108/SS**

REV: _____

8 7 6 5 4 3 2 1

8 7 6 5 4 3 2 1

D
C
B
A

D
C
B
A

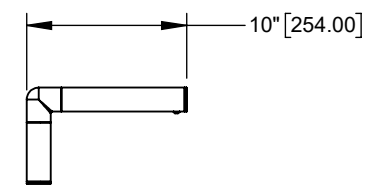
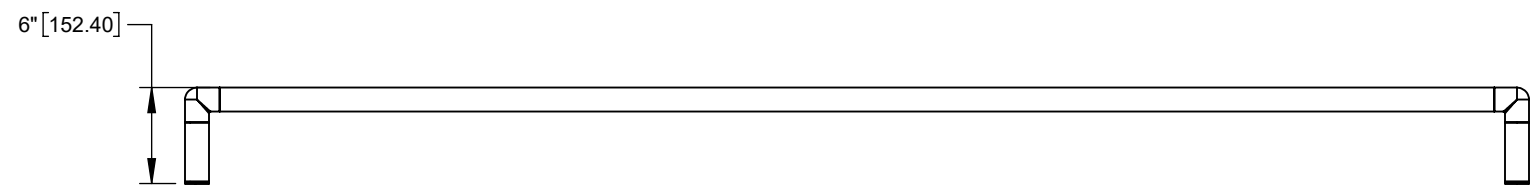
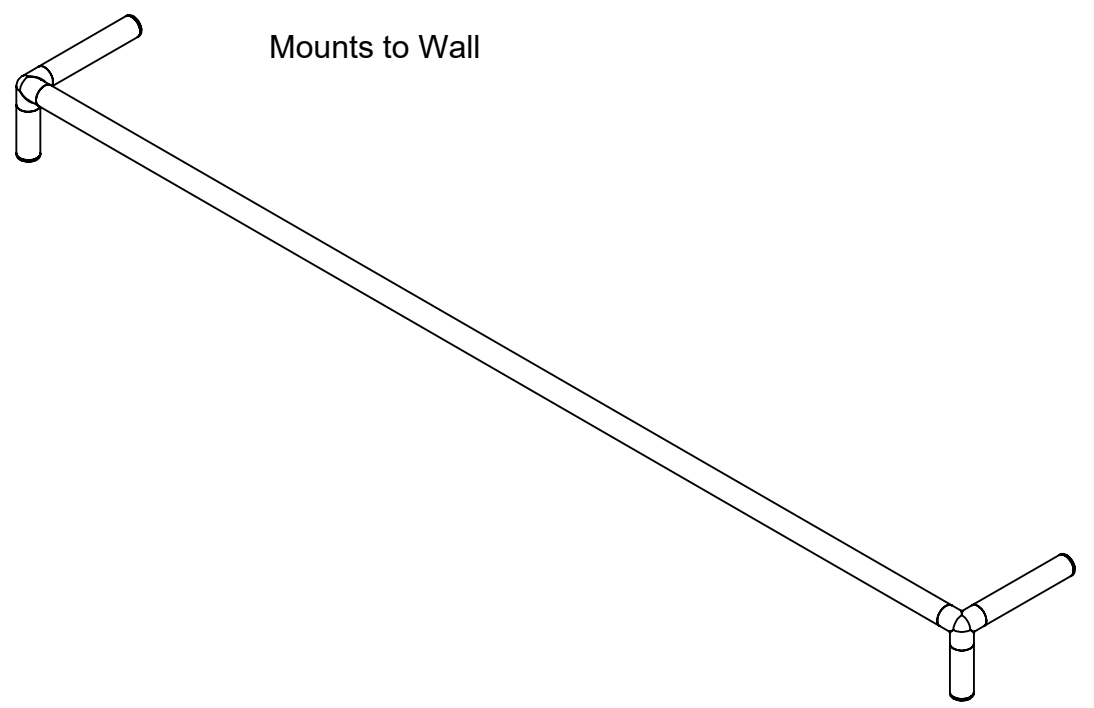
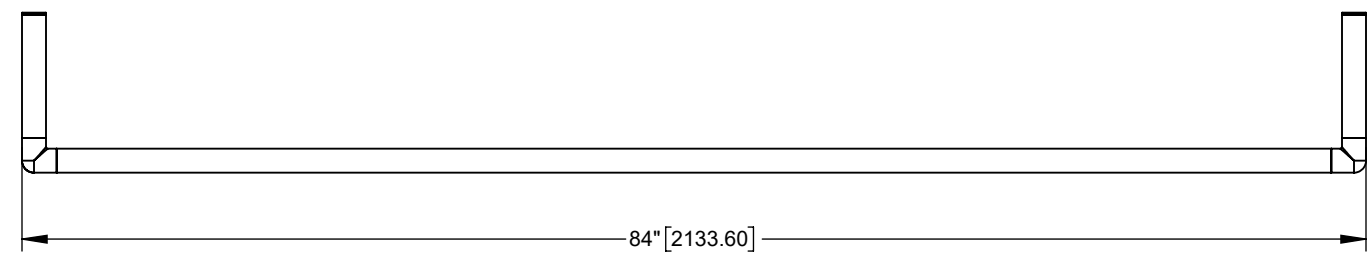

ADA Rail System
 84" Detectable Barrier
 Single 98, Dual 49 Inch Displays

Material:
 Stainless Steel Tubing, 316 Satin SS, 1.5" OD, 0.06" Wall

 SALAMANDER DESIGNS		811 BLUE HILLS AVE. BLOOMFIELD, CT 06002 T/ 860.313.0525 / F/ 860.313.0526		SIZE B
TITLE: ADA Rail System One, 84" (7') Front Rail, Satin Stainless				
MATERIAL SEE NOTE		SURFACE TREATMENT		
DRAWN BY	DATE	HEAT TREATMENT		
ENGINEER	CHECKED BY	SCALE 1:12	SHEET 2 OF 5	
DRAWING NUMBER AR1/84/SS			REV	

8 7 6 5 4 3 2 1

8 7 6 5 4 3 2 1

D
C
B
A

D
C
B
A

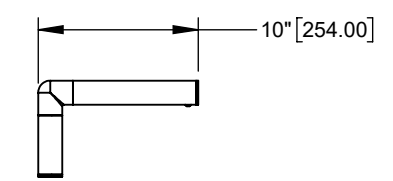
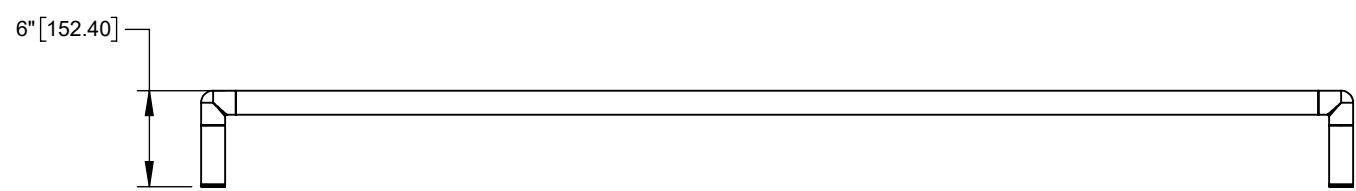
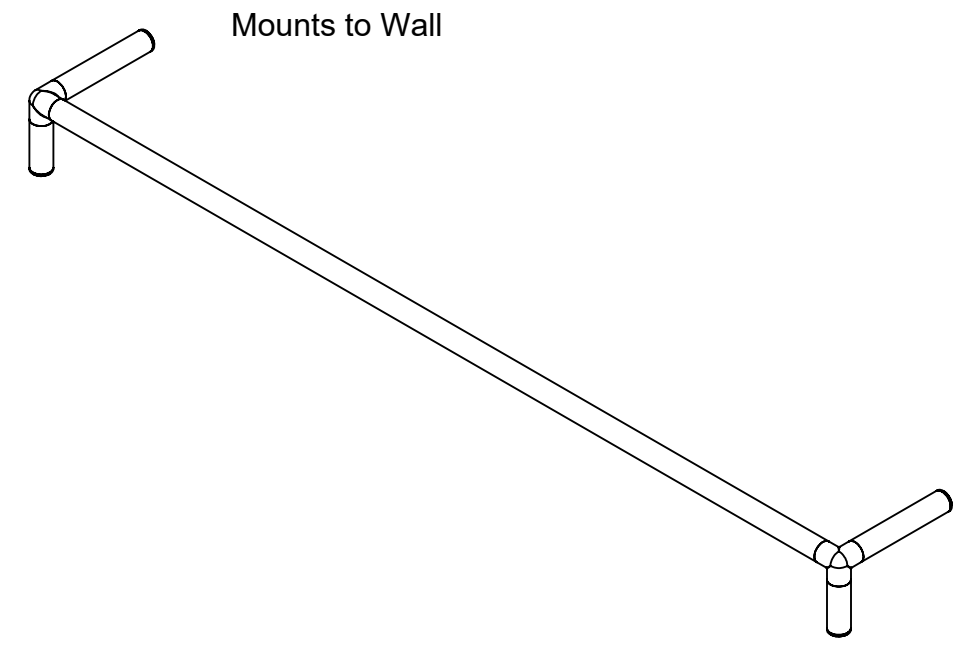
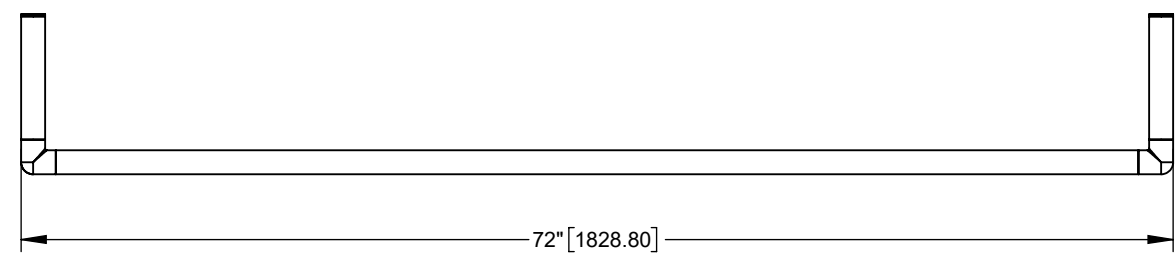

ADA Rail System
 72" Detectable Barrier
 Single 85, 86, Dual 43 Inch Displays

Material:
 Stainless Steel Tubing, 316 Satin SS, 1.5" OD, 0.06" Wall

		811 BLUE HILLS AVE. BLOOMFIELD, CT 06002 T/ 860.313.0525 / F/ 860.313.0526		SIZE B
TITLE: ADA Rail System One, 72" (6') Front Rail, Satin Stainless				
MATERIAL SEE NOTE		SURFACE TREATMENT		
DRAWN BY	DATE	HEAT TREATMENT		
ENGINEER	CHECKED BY	SCALE 1:12	SHEET 3 OF 5	
DRAWING NUMBER AR1/72/SS			REV	

8 7 6 5 4 3 2 1

8 7 6 5 4 3 2 1

D
C
B
A

D
C
B
A

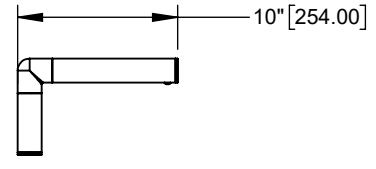
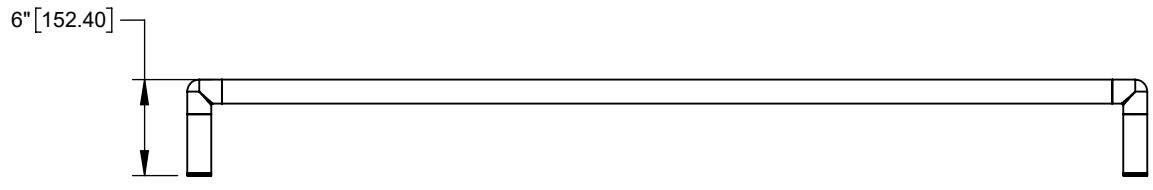
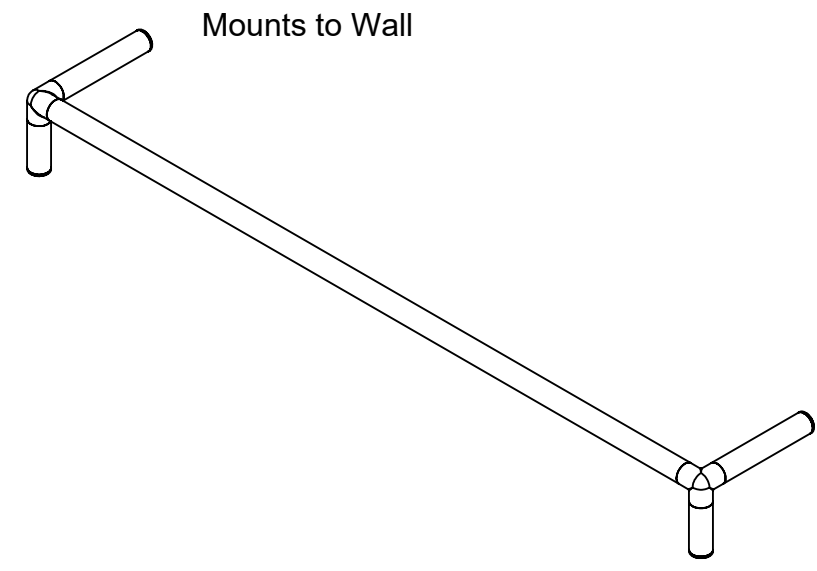
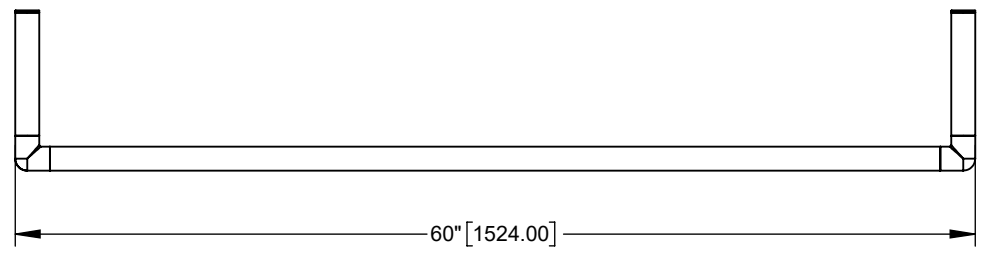

ADA Rail System
60" Detectable Barrier
Single 65, 75 Inch Displays

Material:
Stainless Steel Tubing, 316 Satin SS, 1.5" OD, 0.06" Wall

		811 BLUE HILLS AVE. BLOOMFIELD, CT 06002 T/ 860.313.0525 / F/ 860.313.0526		SIZE B
TITLE: ADA Rail System One, 60" (5') Front Rail, Satin Stainless				
MATERIAL SEE NOTE		SURFACE TREATMENT		
DRAWN BY	DATE	HEAT TREATMENT		
ENGINEER	CHECKED BY	SCALE 1:12	SHEET 4 OF 5	
DRAWING NUMBER AR1/60/SS			REV	

8 7 6 5 4 3 2 1

8 7 6 5 4 3 2 1

D
C
B
A

D
C
B
A

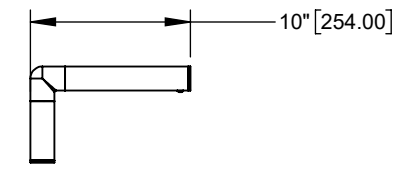
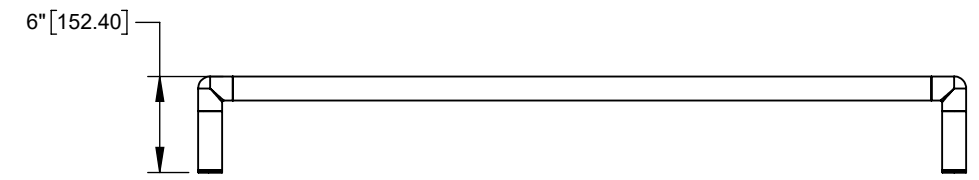
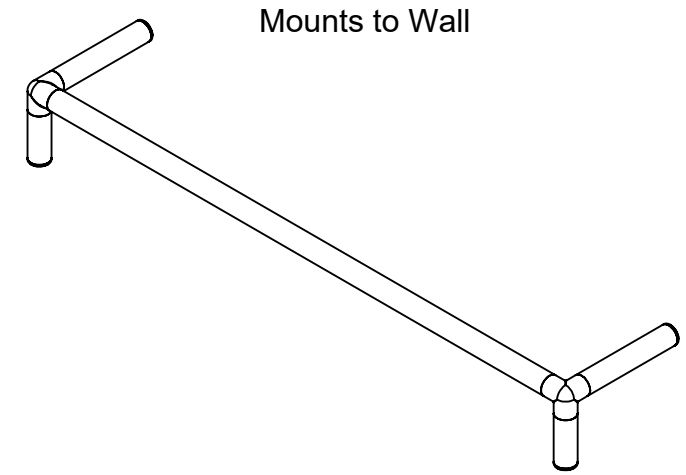
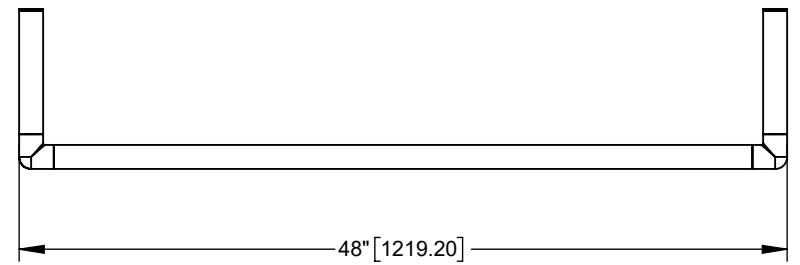

ADA Rail System
 48" Detectable Barrier
 Single 43, 49, 55 Inch Displays

Material:
 Stainless Steel Tubing, 316 Satin SS, 1.5" OD, 0.06" Wall

		811 BLUE HILLS AVE. BLOOMFIELD, CT 06002 T/ 860.313.0525 / F/ 860.313.0526		SIZE B
TITLE: ADA Rail System One, 48" (4') Front Rail, Satin Stainless				
MATERIAL SEE NOTE		SURFACE TREATMENT		
DRAWN BY	DATE	HEAT TREATMENT		
ENGINEER	CHECKED BY	SCALE 1:12	SHEET 5 OF 5	
DRAWING NUMBER AR1/48/SS			REV	

8 7 6 5 4 3 2 1