



MC1000-S



MC1000-XL



MC1000-D



MC1000-XLD

The all metal **MC1000** cart available in multiple display mount configurations is the ideal cart when durability and mobility is mandated. This pair perfectly lends itself to most educational, teaching, business, military, courtroom and corporate training environments.

**Standard Features**

**MC1000 Cart**

- 280 lbs. total TV capacity
- Welded steel construction
- Acrylic locking front door and rear removable access panel
- Built in handles for easy maneuvering
- 13U front useable rack rails
- Ready for optional speakers behind side panels
- Perforated metal sides for maximum ventilation
- Wide wheel base for added stability
- 5" heavy duty casters (2 locking)

**Single, XL, Dual or XL Dual Mount**

- Sturdy 11ga steel, powder coated texture black
- Wiring channel inside main pillar
- Adjustable TV and camera height during setup
- Tilt adjustment during setup

**TV Sizes**

- MC1000-S (1x 40"-70")
- MC1000-XL (1x 70"-90")
- MC1000-D (2x 42"-70")
- MC1000-XLD (2x 70"-85")

**Specifications**

**Model:** MC1000-S | XL | D | XLD  
**Width:** 53-3/4" | 79-5/8" | 84" | 106"  
**Depth:** 23-3/4"  
**Height:** 64"+  
**Color:** Black

**Options**

- **FAN** 120mm AC cooling fan
- **SBB** Sound bar bracket
- **PM-CMP** Codec mounting plate
- **CBB-TV** Under TV camera bracket (26" - 80" TV's)
- **BKT-ST60** Cisco SpeakerTrack60 camera bracket
- **BKT-ROOM** Cisco Room & Room Plus camera bracket
- **BKT-C20** C20 Codec bracket
- **BKT-SX20** SX20 Codec bracket
- **BKT-MCM** Mac Mini bracket
- **PB** 6 Outlet 110V Power Bar
- **RR14** 14U Set of rack rails
- **9031-1/2/3** Utility vented metal shelf
- **9041** Sliding shelf
- **9052-2/9052-3** Sliding drawer
- **M38L** 4x Levelers for non-mobile applications

MC1000 Dimensional Drawings

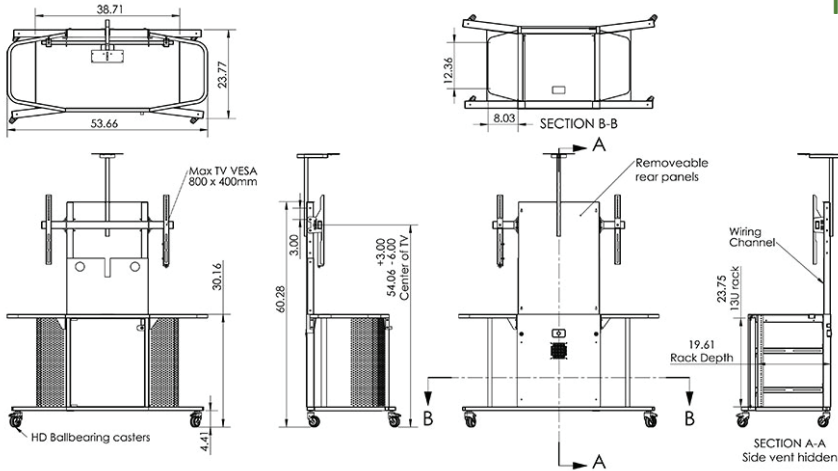

MC1000-S

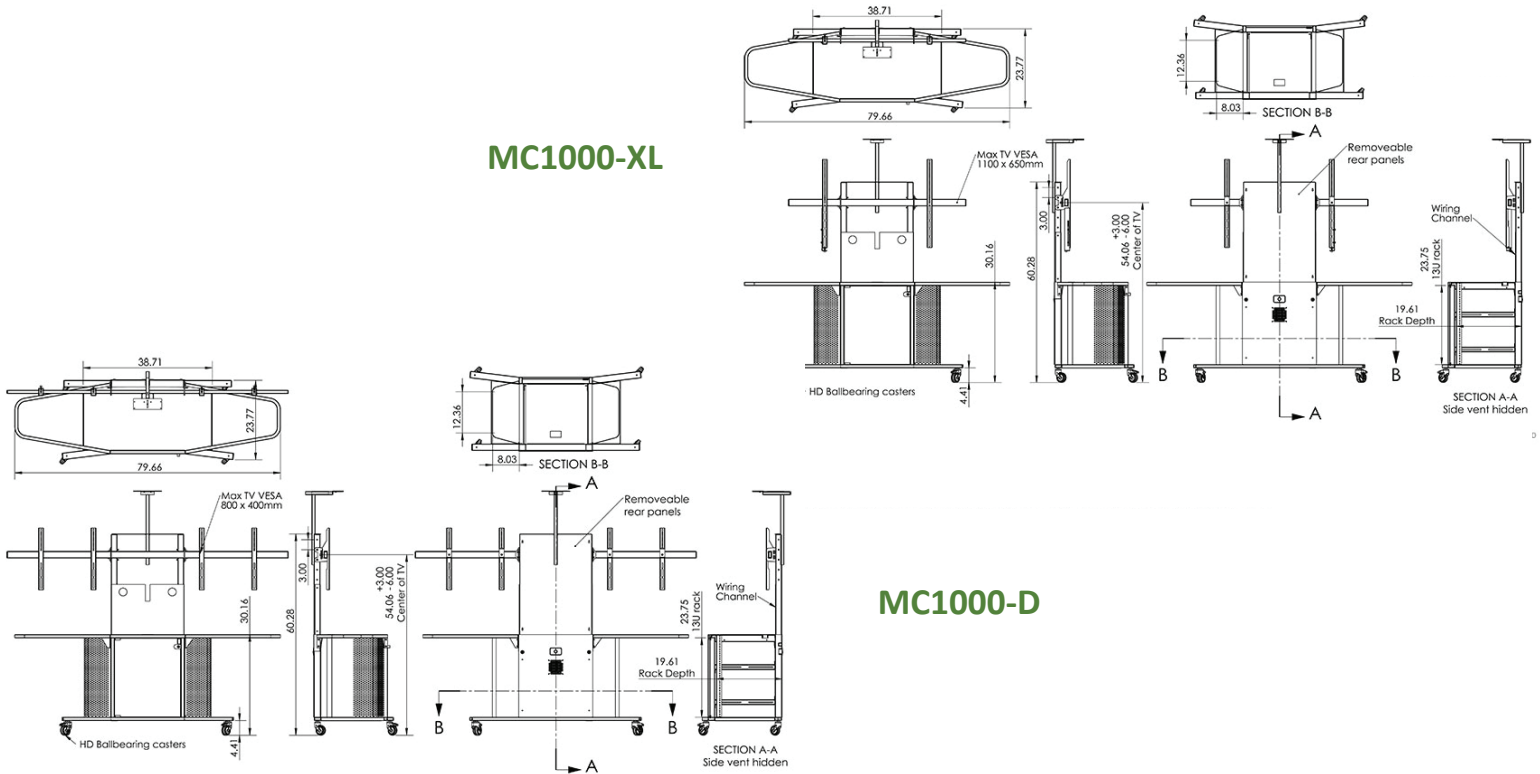

MC1000-XL

MC1000-D

MC1000-XLD

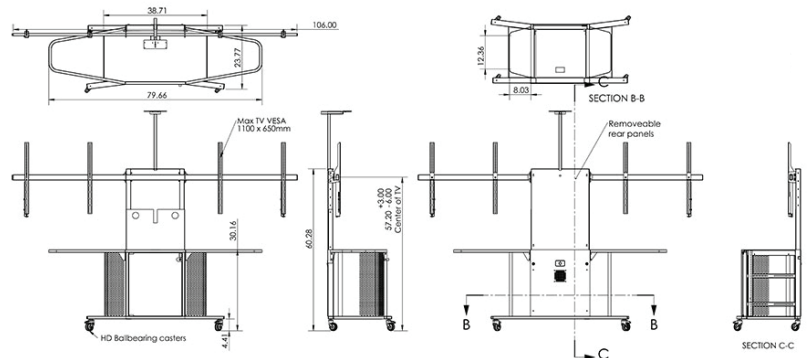

The information contained in this drawing is the sole property of Audio Visual Furniture International. Any reproduction in part or as a whole without the written permission of Audio Visual Furniture International is prohibited. We can build or modify stock configurations to suit customer specifications. Please contact us to discuss how this service can help meet your needs. Some quantity restrictions may apply. Specification subject to change without notice. Computers, cameras, monitors, etc. are shown to illustrate product usage and are not included unless otherwise noted.