

PRA-CSLD Desktop LCD call station

PRAESENSA



This call station for use in PRAESENSA Public Address and Voice Alarm systems is easy to install and intuitive to operate because of its touch screen LCD, providing clear user feedback about setting up a call and monitoring its progress, or controlling background music.

The call station allows for positioning without much effort, because it only requires a connection to an OMNEO IP-network with Power over Ethernet (PoE) for communication and power supply combined. The housing is fit for surface mounting and flush mounting.

It can be configured for use as business call station, but also as emergency call station.

The stylish design incorporates a supervised microphone, an internal monitor loudspeaker and a socket to insert a local audio source for background music.

The 4.3" high-resolution full-color capacitive touch screen gives the operator optimum control and feedback at all times.

Add up to four PRA-CSE call station extensions for zone selection and other functions. Without extensions the call station can only be used with a pre-configured zone selection.

Functions

IP-network connection

- Direct connection to the IP-network. One shielded Ethernet cable is sufficient for Power over Ethernet and data exchange.
- Connect a second shielded Ethernet cable for dual redundancy of network and of power connection.

- ▶ Desktop housing with gooseneck microphone
- ▶ 4.3" full-color capacitive touch screen
- ▶ Graphical user interface for optimum user guidance and feedback
- ▶ Status and fault indicators for voice alarm purposes
- ▶ Dual OMNEO IP-network connection and redundant Power over Ethernet

- Integrated network switch with two OMNEO ports allows for loop-through connections to adjacent devices (at least one must provide PoE). Rapid Spanning Tree Protocol (RSTP) is supported to enable recovery from failing network links.

Business operation

- Full color 4.3" capacitive touch screen with intuitive function menu navigation provides guidance and feedback during the process of live announcements, pre-recorded messages and music control. Successful broadcast of announcements/ messages and changes to the background music settings are clearly indicated.
- Press-to-talk button gives tactile feedback and is recessed to prevent accidental use.
- Built-in monitor loudspeaker with volume control.
- Local audio line input (with stereo to mono conversion) for connecting an external audio source. The audio channel will be available on the network and can be played in any loudspeaker zone.
- Connection of up to four PRA-CSE extensions, each with twelve buttons. The buttons can be configured for various functions, but they are especially useful for zone selection, giving a clear overview of accessible zones and the LED indicators for each button show the status of the respective zone (like being selected, occupied or at fault).
- A User number and PIN code can protect the device in public places against unauthorized access.

- If the call station is not used for a while, it will switch to sleep mode to save energy. It will immediately wake up when the screen, or a button, is touched.

Emergency operation

- The call station fully complies to the standards for voice alarm applications when the fireman's user interface is configured and at least one PRA-CSE is connected to it.
- All critical alarm functions are accessible via buttons for operators wearing gloves. The 4.3" screen gives feedback on the system status.
- Each of the two RJ45 network connectors accept PoE to power the call station. This provides fail-safe network connection redundancy, as one connection is sufficient for full operation.
- Supervision of all critical elements; the audio path is supervised, as well as the communication to the network.

Connection and functional diagram

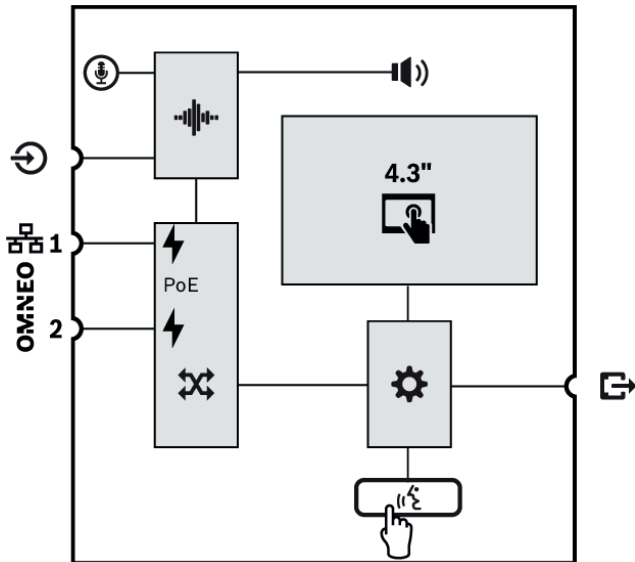

	Fixed microphone on a flexible stem		Internal monitor loudspeaker
	Audio processing (DSP)		Power over Ethernet
	OMNEO network switch		Controller
	Press-To-Talk button		

Top side



Top side indicators

	Power on Device in identification mode	Green Green blinking
	System fault present	Yellow
	Status business call Microphone active Chime/message active	Green Green blinking
	Status emergency call Microphone active Alarm tone/message active	Red Red blinking
	4.3" full-color capacitive touch screen	LCD
	Identification mode / Indicator test	All LEDs blink

Top side controls

	Press-To-Talk	Button
	4.3" full-color capacitive touch screen	LCD

Bottom side







Bottom side indicators

	100 Mbps network 1-2 1 Gbps network 1-2	Yellow Green
---	--	-----------------

Bottom side controls

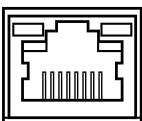
	Device reset (to factory default)	Button
---	-----------------------------------	--------

Bottom-side and side interconnections

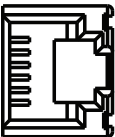
	Network port 1-2 (PoE PD)	
	Local source audio line input	
	PRA-CSE interconnection (RJ12)	

Architects' and engineers' specifications

The IP-networked desktop call station shall be designed exclusively for use with Bosch PRAESENSA systems. The desktop call station shall provide an interface for control data and multi-channel digital audio over OMNEO using dual Ethernet ports for redundant network connection, supporting RSTP and loop-through cabling. It shall receive Power over Ethernet (PoE) via either one or both network connections. The desktop call station shall provide a backlit full-color capacitive touch panel LCD as user interface for business and evacuation purposes. The

desktop call station shall accept up to four optional extensions, each offering 12 configurable buttons for zone selection and other purposes. It shall provide control and routing of live speech calls, stored messages and music with volume control per zone. Authentication on the LCD with user number and PIN code shall protect the device against unauthorized access. The desktop call station shall have a gooseneck cardioid microphone for live calls and a 3.5 mm jack line level input for background music, and provide software-configurable signal processing including sensitivity control, parametric equalization and limiting. The desktop call station shall be certified for EN 54-16 / ISO 7240-16, marked for CE and be compliant with the RoHS directive. Warranty shall be three years minimum. The desktop call station shall be a Bosch PRA-CSLD.

Regulatory information

Emergency standard certifications

Europe	EN 54-16 (0560-CPR-182190000)
International	ISO 7240-16
Maritime applications	DNV GL Type Approval

Emergency standard compliance

Europe	EN 50849
UK	BS 5839-8

Regulatory areas

Safety	EN/IEC/CSA/UL 62368-1
Immunity	EN 55035 EN 50130-4
Emissions	EN 55032 EN 61000-6-3 ICES-003 FCC-47 part 15B class A
Environment	EN/IEC 63000
Railway applications	EN 50121-4
Maritime applications	EN 60945

Parts included

Quantity	Component
1	Desktop LCD call station
1	Bracket (attached to bottom)
1	Connector cover (attached to bottom)

Quantity	Component
1	Quick installation guide
1	Safety and security information

Technical specifications

Electrical

Microphone	
Nominal acoustic input level (dB SPL) (configurable)	80 dB SPL – 100 dB SPL
Maximum acoustic input level (dB SPL)	120 dB SPL
Minimum signal-to-noise ratio (dBA)	70 dBA
Self noise (dB SPL)	< 26 dB SPL
Polar pattern	Unidirectional
Frequency response (Hz)	100 Hz – 14,000 Hz

Display	
Display size (in)	4.30 in
Touchscreen	Capacitive
Color depth	24-bit
Display resolution (pixels)	480 x 272 px
Brightness	300 cd/m ²

Monitor loudspeaker	
Maximum sound pressure level, at 1 m	75 dB SPL
Volume control	Mute, -40 dB – 0 dB
Frequency range (-10 dB) (Hz)	400 Hz – 8,000 Hz

Line input	
Minimum signal-to-noise ratio (dBA)	96 dBA
Frequency response (-3 dB) (Hz)	20 Hz – 20,000 Hz
Total harmonic distortion + noise (%)	0.10%

Power transfer	
PoE input	PoE IEEE 802.3af Class 3

Nominal voltage (VDC) (input)	48 VDC
Input voltage (VDC) (tolerance)	37 VDC – 57 VDC
Power consumption (W) (business use)	4.2 W
Power consumption (W) (emergency use)	5.4 W
Power consumption (W) (per call station extension, indicators off / on)	0.1 W / 1.0 W

Supervision

Microphone	Current
Audio path	Pilot tone
Controller continuity	Watchdog
PoE (1-2)	Voltage

Network interface

Ethernet type	100BASE-TX; 1000BASE-T
Ethernet protocol	TCP/IP
Redundancy	RSTP
Audio/control protocols	OMNEO
Latency (ms)	10 ms
Audio encryption	AES 128
Security	TLS
Number of Ethernet ports	2

Reliability

Mean time between failures (MTBF) (h) (Telcordia SR-332 Issue 3)	1,000,000 h
--	-------------

Environmental

Operating temperature (°C)	-5 °C – 50 °C
Operating temperature (°F)	23 °F – 122 °F
Storage temperature (°C)	-30 °C – 70 °C
Storage temperature (°F)	-22 °F – 158 °F
Operating relative humidity, non-condensing (%)	5% – 95%

Air pressure (hPa)	560 hPa – 1,070 hPa
Installation altitude (m)	-500 m – 5,000 m
Installation altitude (ft)	-1,640 ft – 16,404 ft
Vibration (operating)	
Amplitude	< 0.35 mm
Acceleration	< 5 G
Bump (transport)	< 10 G (IEC 60068-2-27)

Mechanical

Dimensions (H x W x D) (mm) (excluding microphone)	62 mm x 130 mm x 189 mm
Dimensions (H x W x D) (in) (excluding microphone)	2.44 in x 5.12 in x 7.44 in
IP rating	IP30
Material	Plastic; Zamac
Color (RAL)	RAL 9017 Traffic black; RAL 9022 Pearl light grey
Weight (kg)	0.90 kg
Weight (lb)	1.98 lb

Ordering information

PRA-CSLD Desktop LCD call station
 Network-connected, PoE powered, touch screen call station with gooseneck microphone.
 Order number **PRA-CSLD | F.01U.325.048**

Services
EWE-PRALCD-IW 12 mths wrty ext Praes LCD Call station
 12 months warranty extension
 Order number **EWE-PRALCD-IW | F.01U.387.318**

Represented by:

Europe, Middle East, Africa:
 Bosch Security Systems B.V.
 P.O. Box 80002
 5600 JB Eindhoven, The Netherlands
www.boschsecurity.com/xc/en/contact/
www.boschsecurity.com

Germany:
 Bosch Sicherheitssysteme GmbH
 Robert-Bosch-Platz 1
 D-70839 Gerlingen
www.boschsecurity.com

North America:
 Bosch Security Systems, LLC
 130 Perinton Parkway
 Fairport, New York, 14450, USA
www.boschsecurity.com

Asia-Pacific:
 Robert Bosch (SEA) Pte Ltd, Security Systems
 11 Bishan Street 21
 Singapore 573943
www.boschsecurity.com/xc/en/contact/
www.boschsecurity.com