

SHURE

MICROFLEX[®]

MICROPHONES



THERE'S NEVER BEEN A MORE FLEXIBLE CHOICE.

Work a room in more ways than ever with Shure Microflex microphones. Combining sleek, low profile aesthetics and a complete selection of microphones and mounting options, the Microflex line offers the highest standard of quality and efficiency for installed audio applications.

MICROFLEX GOOSENECK MICROPHONES

- Models in lengths from 12-62 cm (5-24 inches) fit a wide variety of applications from the podium to the conference table
- Interchangeable condenser cartridges with superior audio quality

MICROFLEX BOUNDARY MICROPHONES

- Multi-element, low-profile, or wireless microphone styles available
- Extremely versatile range of placement options for easy configuration and installation

MICROFLEX OVERHEAD MICROPHONES

- Compact and adjustable 10 cm (4") gooseneck
- Interchangeable condenser cartridges for accurate sound reproduction in any setting

MICROFLEX LAVALIER AND EARSET MICROPHONES

- For applications requiring low-profile discreet placement
- Use in wired or wireless applications

APPLICATIONS

Conference Rooms

Seminars

Houses of Worship

Theaters

Courtrooms

Lecterns

PRODUCT HIGHLIGHTS

Wide selection for customized installations

Wired or wireless models available

Superior audio quality

CommShield™ Technology for improved RF resistance

Sleek, low-profile designs

MX405, MX410, MX415 MODULAR GOOSENECK MICROPHONES

Flexible in more ways than one, Microflex Modular Gooseneck Microphones deliver unsurpassed style and performance for conference rooms and similar applications. Offering desktop or mounted bases, wired or wireless options, and even interchangeable cartridges, it's easy to get the perfect fit for your application. Fully compatible with Microflex Wireless Systems and ULX-D Systems.

Specifications

Type	Condenser (electret bias)
Frequency Response	50 Hz – 17 kHz
Polar Pattern	MX405/C, MX410/C, MX415/C: Cardioid MX405/S, MX410/S, MX415/S: Supercardioid MX405/MS Lobar Mini-Shotgun
Output Impedance	EIA rated at 150 Ω (170 Ω actual)
Output Configuration	Active balanced
Sensitivity at 1 kHz, open circuit voltage; 1 Pascal = 94 dB SPL	Cardioid: -35 dBV/Pa (18 mV) Supercardioid: -34 dBV/Pa (21 mV) Lobar: -33 dBV/Pa (22 mV)a
Maximum SPL 1 kHz at 1% THD, 1 kΩ load	Cardioid: 121 dB Supercardioid: 120 dB Lobar: 121 dB SPL
Equivalent Output Noise A-weighted	Cardioid: 28 dB SPL Supercardioid: 27 dB SPL Lobar: 36 dB
Signal-to-Noise Ratio referenced at 94 dB SPL at 1 kHz	Cardioid: 66 dB Supercardioid: 67 dB Lobar: 68 dB
Dynamic Range 1 kΩ load at 1 kHz	93 dB
Common Mode Rejection 10 Hz to 100 kHz	45 dB minimum
Preamplifier Output Clipping Level 1% THD	-8 dBV (0.4 V)
Polarity	3-Pin XLR: Positive sound pressure on diaphragm produces positive voltage on pin 2 relative to pin 3 of output XLR connector. 5-Pin XLR: Positive sound pressure on diaphragm produces positive voltage on pin 4 relative to pin 2 of output XLR connector.
Weight	MX405: 54 g MX410: 68 g MX415: 70 g MX400DP: 516 g MX400SMP (w/ Kit): 125 g
Logic Connections	LED IN: Active low (≤1.0 V), TTL compatible. Absolute maximum voltage: -0.7 V to 50 V. LOGIC OUT: Active low (≤1.0 V), sinks up to 20 mA, TTL compatible. Absolute maximum voltage: -0.7 V to 50 V (up to 50 V through 3 kΩ).
Mute Switch Attenuation	-50 dB minimum
Cable	MX400DP: 6 m attached cable with shielded audio pair terminated at a 3-pin male XLR and three unterminated conductors for logic control
Environmental Conditions	Operating temperature: -18 – 57 °C Storage temperature: -29 – 74 °C Relative humidity: 0 – 95%
Power Requirements	48 – 52 Vdc phantom, 8.0 mA

*for detailed dimensions please reference MX405/410/415 user guide

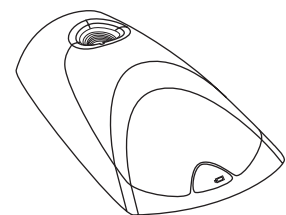
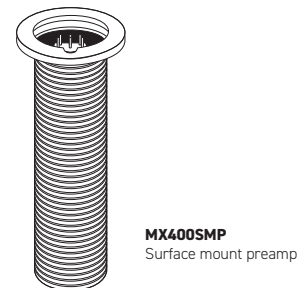
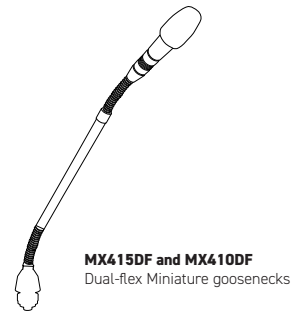
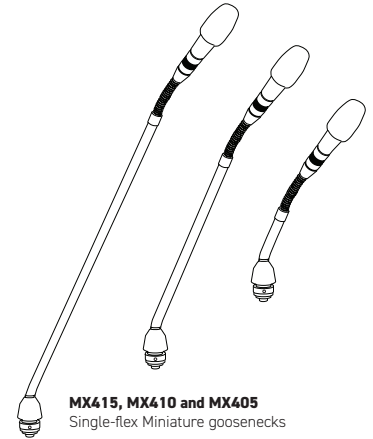

Available Models

The polar pattern of the cartridge is indicated by the model number suffix: C = Cardioid, S = Supercardioid, N = No Cartridge, MS = Lobar

MX405/N, MX405/C, MX405/S, MX405/MS	127 mm (5 inch) gooseneck, bi-color status indicator, includes surface mount preamp
MX405R/N, /C, /S, /MS	127 mm (5 inch) gooseneck, light ring, includes surface mount preamp
MX410/C, /S	254 mm (10 inch) gooseneck, bi-color status indicator, includes surface mount preamp
MX410R/N	254 mm (10 inch) gooseneck, light ring, includes surface mount preamp
MX415/C, /S	381 mm (15 inch) gooseneck, bi-color status indicator, includes surface mount preamp
MX415R/N	381 mm (15 inch) gooseneck, light ring, includes surface mount preamp
MX405LP/N, /C, /S, /MS	127 mm (5 inch) gooseneck, bi-color status indicator, less preamp
MX405RLP/N, /C, /S, /MS	127 mm (5 inch) gooseneck, light ring, less preamp
MX405WLP/N	127 mm (5 inch) gooseneck, bi-color status indicator, less preamp, white
MX405WRLP/N	127 mm (5 inch) gooseneck, light ring, less preamp, white
MX410LP/C, /S	254 mm (10 inch) gooseneck, cardioid, bi-color status indicator, less preamp
MX410RLP/N	254 mm (10 inch) gooseneck, light ring, less preamp
MX410LPDF/C, /S	254 mm (10 inch) gooseneck, bi-color status indicator, less preamp, dualflex
MX410RLPDF/C, /S	254 mm (10 inch) gooseneck, light ring, less preamp, dualflex

MX405, MX410, MX415 MODULAR GOOSENECK MICROPHONES

Available Models (Continued)

The polar pattern of the cartridge is indicated by the model number suffix: C = Cardioid, S = Supercardioid, N = No Cartridge, MS = Lobar

MX410RLPDF/N	254 mm (10 inch) gooseneck, light ring, less preamp, dualflex
MX410WLP/N	254 mm (10 inch) gooseneck, light ring, less preamp, Dualflex, white
MX415LP/C, /S	381 mm (15 inch) gooseneck, cardioid, bi-color status indicator, less preamp
MX415RLP/N	381 mm (15 inch) gooseneck, light ring, less preamp
MX415LPDF/C, /S	381 mm (15 inch) gooseneck, bi-color status indicator, less preamp, dualflex
MX415RLPDF/C, /S	381 mm (15 inch) gooseneck, light ring, less preamp, dualflex
MX415RLPDF/N	381 mm (15 inch) gooseneck, light ring, less preamp, dualflex

Optional Accessories and Replacement Parts

MX400SMP	Surface mount preamp	R185B	Black cardioid cartridge for all Microflex models	A412MWS	Metal locking windscreen
MX400DP	Wired desktop base. Includes 6.1 m attached cable	R184B	Black supercardioid cartridge for all Microflex models	95A2487	Tapered windscreen
R185W-A	White cardioid cartridge for all white Microflex models	R183B	Black Omnidirectional cartridge for all Microflex models	R189B	Black lobar mini-shotgun cartridge for black Microflex models
R189W-A	White Lobar cartridge for all white Microflex models	R184W-A	White Supercardioid cartridge for all white Microflex models	R183W-A	White Omnidirectional cartridge for all white Microflex models

Furnished Accessories

Models with included Preamp

MX400SMP	Surface mount preamp
65A405	Rubber isolation rings
65A2190	Wing nut
95A2529	5-pin XLR-F
65A2166	Cap

All Models

RK513WS	Black snap-fit foam windscreen (4 pcs.)	A189WWS-A	White flocked snap-fit foam minishotgun windscreen
RK514	White snap-fit foam windscreen (4 pcs.)	A189BWS	Black minishotgun windscreen
A410WWS-A	White flocked snap-fit foam windscreen	A189WWS	White mini-shotgun windscreen

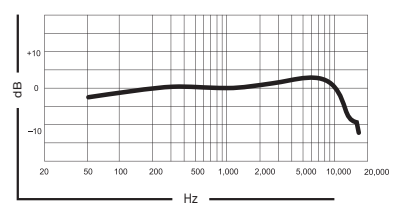
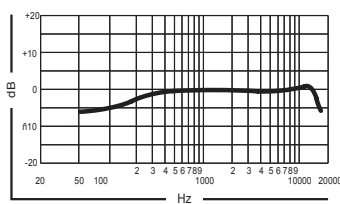
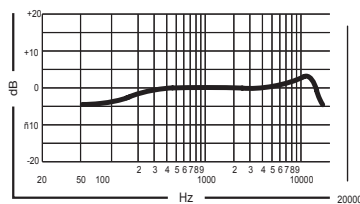
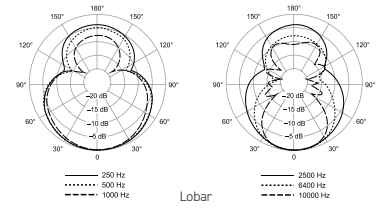
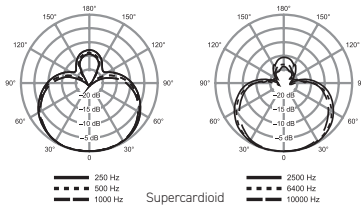
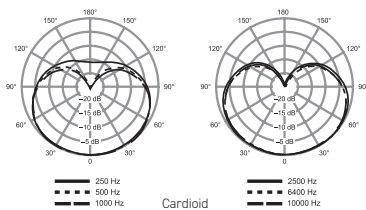

MX412, MX418, MX424 STANDARD GOOSENECK MICROPHONES

Microflex Standard Gooseneck Microphones provide the added length and flexibility needed for speakers in environments like lecterns, pulpits, and courtrooms. Available in four models with a variety of lengths and mounting styles to choose from, Microflex Gooseneck microphones feature high sensitivity and balanced, transformerless output for maximum resistance to electromagnetic hum and RF interference, even over long cable runs.

Specifications

Type	Condenser (electret bias)
Frequency Response	50 Hz – 17 kHz
Polar Pattern	MX412/C, MX418/C, MX424/C: Cardioid MX412/S, MX418/S, MX424/S: Supercardioid Omnidirectional cartridge available separately
Output Impedance	EIA rated at 150 Ω (170 Ω actual)
Sensitivity at 1 kHz, open circuit voltage; 1 Pascal = 94 dB SPL	Cardioid: -35 dBV/Pa (17.8 mV) Supercardioid: -33.5 dBV/Pa (21.1 mV) Omnidirectional: -27.5 (42.2 mV)
Maximum SPL 1 kHz at 1% THD, 1 kΩ load	Cardioid: 124.2 dB Supercardioid: 122.7 dB Omnidirectional: 116.7 dB
Equivalent Output Noise A-weighted	Cardioid: 28 dB SPL Supercardioid: 26.5 dB SPL Omnidirectional: 20.5 dB SPL
Signal-to-Noise Ratio referenced at 94 dB SPL at 1 kHz	Cardioid: 66 dB Supercardioid: 67.5 dB Omnidirectional: 73.5 dB
Dynamic Range 1 kΩ load at 1 kHz	96.2 dB 100 dB at 0 gain (internal modification)
Common Mode Rejection	45 dB minimum (10 Hz – 100 kHz)
Preamplifier Output Clipping Level 1% THD	-6 dBV (0.5 V)
Polarity	Positive sound pressure on diaphragm produces positive voltage on pin 2 relative to pin 3 of output XLR connector.
Mute Switch Attenuation	-50 dB minimum
Cable	MX412D and MX418D: The 3 m attached custom cable contains a shielded audio pair and three unshielded conductors for logic control. Overall diameter = 4 mm
Environmental Conditions	Operating temperature range: -18° – 57° C Relative humidity: 0 – 95%
Power Requirements	11 – 52 Vdc phantom, 8.0 mA

*for detailed dimensions please reference MX412/418/424 user guides



MX412, MX418 and MX424
Standard Gooseneck Microphones

Available Models

The polar pattern of the cartridge is indicated by the model number suffix: C = Cardioid, S = Supercardioid, N = No Cartridge

MX412/C, MX412/S, MX412/N	331 mm (13 inch) gooseneck, attached XLR preamp, shock mount, flange mount, snap-fit foam windscreen
MX418/C, MX418/S, MX418/N	473 mm (19 inch) gooseneck, attached XLR preamp, shock mount, flange mount, snap-fit foam windscreen
MX412S/C, MX412S/S, MX412S/N	334 mm (13 inch) gooseneck, attached XLR preamp, shock mount, flange mount, snap-fit foam windscreen, mute switch, LED Indicator
MX418S/C, MX418S/S, MX418S/N	473 mm (19 inch) gooseneck, attached XLR preamp, shock mount, flange mount, snap-fit foam windscreen, mute switch, LED indicator
MX412SE/C, MX412SE/S, MX412SE/N	305 mm (12 inch) gooseneck, in-line preamp, shock mount, flange mount, 3 m side-exit (or bottom-exit) cable, snap-fit foam windscreen
MX418SE/C, MX418SE/S, MX418SE/N	457 mm (18 inch) gooseneck, in-line preamp, shock mount, flange mount, 3 m side-exit (or bottom-exit) cable, snap-fit foam windscreen
MX412D/C, MX412D/S, MX412D/N	305 mm (12 inch) gooseneck, desktop base with 3 m cable, logic functions, programmable switch and LED indicator, snap-fit foam windscreen
MX418D/C, MX418D/S, MX418D/N	457 mm (18 inch) gooseneck, desktop base with 3 m cable, logic functions, programmable switch and LED indicator, snap-fit foam windscreen
MX424/C, MX424/S, MX424/N	623 mm (25 inch) gooseneck, attached XLR preamp, shock mount, flange mount, snap-fit foam windscreen

MX412, MX418, MX424 STANDARD GOOSENECK MICROPHONES

Furnished Accessories

MX412, MX418, MX412S, MX418S, MX424 Models		MX412SE, MX418SE Models		MX412D, MX418D Models	
65B8264	Flange	A12C	Flange and nut	RK412WS	Snap-fit foam windscreen (1 furnished, 4 in replacement pack)
65B8265	Retainer	80A476	Clamp		
80A439	Isolation ring	A400SM	Shock mount		
RK412WS	Snap-fit foam windscreen (1 furnished, 4 in replacement pack)	RK412WS	Snap-fit foam windscreen (1 furnished, 4 in replacement pack)		
A400SM	Shock mount	31B1762A	Shock mount adapter		
80A67	Hex wrench #4				

Optional Accessories and Replacement Parts

A412B	Desktop base	C130	Custom logic cable (specify length)	R185B	Black cardioid cartridge for all Microflex models
A412MWS	Metal locking windscreen	RK100PK	Replacement in-line preamplifier (SE models)	R189B	Black lobar mini-shotgun cartridge for Microflex models
A99WS	Foam ball windscreen	R183B	Black omnidirectional cartridge for all Microflex models		
A57F	Stand adapter	R184B	Black supercardioid cartridge for all Microflex models		

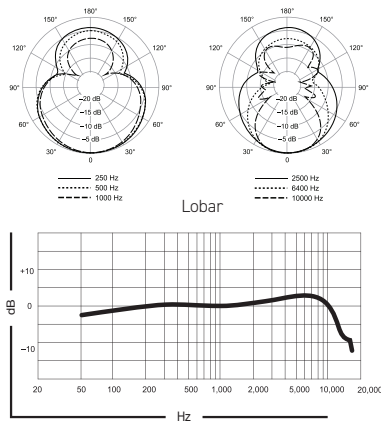
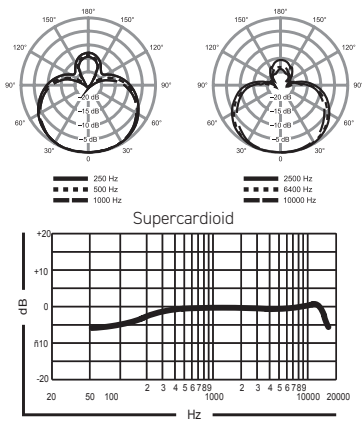
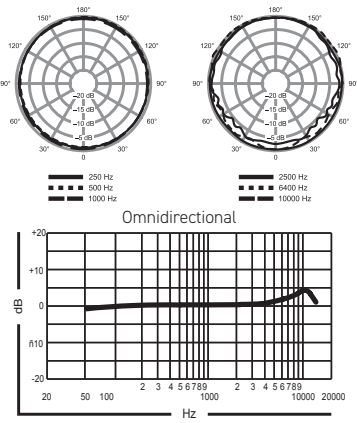
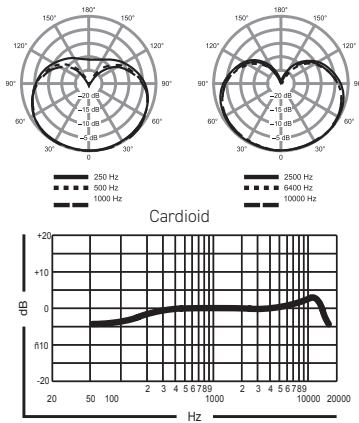

MX396 MULTI-ELEMENT BOUNDARY MICROPHONES

Microflex Multi-Element Boundary Microphones deliver a unique and versatile tool for conference room installations. Clean and simple in appearance, Multi-Element Boundary mics come in two or three element configurations, combining the coverage of multiple microphones into one small, compact package.

Specifications

Type	Condenser (electret bias)
Frequency Response	50 Hz – 17 kHz
Output Impedance	EIA rated at 150 Ω (170 Ω actual)
Output Configuration	Active balanced
Sensitivity at 1 kHz, open circuit voltage; 1 Pa = 94 dB SPL	-35 dBV/Pa (18 mV)
Maximum SPL 1 kHz at 1% THD, 1 kΩ load	122 dB
Equivalent Output Noise A-weighted	28 dB SPL
Signal-to-Noise Ratio referenced at 94 dB SPL at 1 kHz	66 dB
Dynamic Range 1 kΩ load at 1 kHz	94 dB
Common Mode Rejection 10 Hz to 100 kHz	45 dB minimum
Pre-amplifier Output Clipping Level 1% THD	-6 dBV (0.5 V)
Weight	Net: 587 g Packaged: 816 g
Logic Connections	LED IN: Active low ($\leq 1.0\text{ V}$), sinks up to 20 mA, TTL compatible. Absolute maximum voltage: -0.7 V to 50 V (up to 50 V through 3 kΩ). LOGIC OUT: Active low ($\leq 1.0\text{ V}$), sinks up to 20 mA, TTL compatible. Absolute maximum voltage: -0.7 V to 50 V (up to 50 V through 3 kΩ).
Mute Switch Attenuation	-50 dB minimum
Cable	6 m attached unterminated cable with three shielded audio pairs and three shielded conductors for logic control.
Environmental Conditions	Operating temperature: -18 – 57 °C Storage temperature: -29 – 74 °C Relative humidity: 0 – 95%
Power Requirements	MX396/C-DUAL: 48 – 52 Vdc phantom, 10.0 mA MX396/C-TRI: 48 – 52 Vdc phantom, 12.0 mA



MX396 Multi-Element boundary microphone

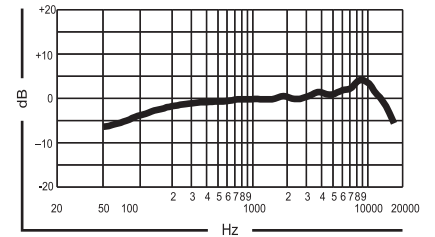
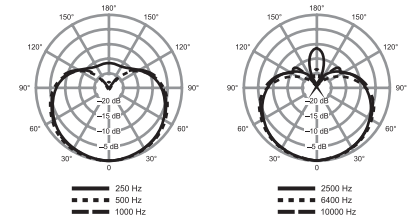

Available Models

MX396/C-DUAL	Dual-Element 0-180 degrees, back or bottom exit cable, mute output, LED input
MX396/C-TRI	Tri-Element 90-0-90 mic, adjustable to 120-120-120 degrees, back or bottom exit cable, mute output, LED input

Furnished Accessories and Replacement Parts

65A2190	Fastening wingnut	R185B	Cardioid replacement cartridge (x 1)
31A2165	Fastening tube	65A405	Rubber isolation rings

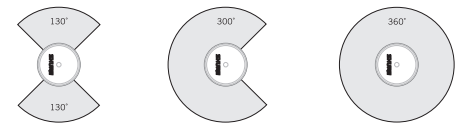

Example of Boardroom Table Mic Placement Coverage

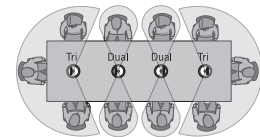

MX395 LOW PROFILE BOUNDARY MICROPHONES

The Microflex Low Profile Boundary Microphone is an ideal table microphone when minimal presence is of high priority. Perfect for meeting rooms, these microphones deliver exceptional sound pickup while barely being noticed. Choose from a selection of colors and pickup patterns for customized table and ceiling installations.

Specifications

Type	Condenser (electret bias)
Frequency Response	50 Hz – 17 kHz
Polar Pattern	MX395/O: Omnidirectional MX395/C: Cardioid MX395/BI: Bidirectional
Output Impedance	EIA rated at 150 Ω (170 Ω actual)
Output Configuration	Active balanced
Sensitivity at 1 kHz, open circuit voltage; 1 Pascal = 94 dB SPL	Cardioid: -35 dBV/Pa (18 mV) Omnidirectional: -28 dBV/Pa (42 mV) Bidirectional: -37 dBV/Pa (14 mV)
Maximum SPL 1 kHz at 1% THD, 1 kΩ load	Cardioid: 121 dB Omnidirectional: 114 dB Bidirectional: 123 dB
Equivalent Output Noise A-weighted	Cardioid: 28 dB SPL Omnidirectional: 21 dB SPL Bidirectional: 29 dB
Signal-to-Noise Ratio referenced at 94 dB SPL at 1 kHz	Cardioid: 66 dB Omnidirectional: 73 dB Bidirectional: 65 dB
Dynamic Range 1 kΩ load at 1 kHz	Cardioid: 93 dB Omnidirectional: 93 dB Bidirectional: 94 dB
Common Mode Rejection	45 dB minimum 10 Hz to 100 kHz
Preamplifier Output Clipping Level 1% THD	-8 dBV (0.4 V)
Polarity	3-pin XLR: Positive sound pressure on diaphragm produces positive voltage on pin 2 relative to pin 3 of output XLR connector. 5-pin XLR: Positive sound pressure on diaphragm produces positive voltage on pin 4 relative to pin 2 of output XLR connector.
Weight	Net: 136 g; Packaged: 374 g
Logic Connections	LED IN: Active low (≤ 1.0 V), TTL compatible. Absolute maximum voltage: -0.7 V to 50 V.
Environmental Conditions	Operating temperature: -18 – 57 °C Storage temperature: -29 – 74 °C Relative humidity: 0 – 95%
Power Requirements	MX395: 11 – 52 Vdc phantom, 2.0 mA MX395-LED: 48 – 52 Vdc phantom, 8.0 mA

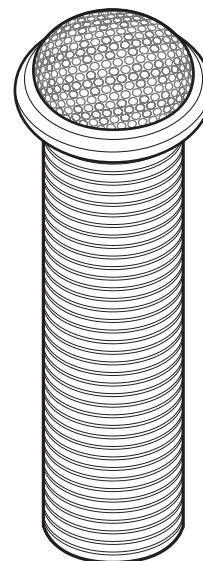

MX395
Low Profile
Boundary Mic

Available Models

The polar pattern of the cartridge is indicated by the model number suffix: C = Cardioid, O = Omnidirectional, BI = Bidirectional

MX395B/C, MX395B/BI, MX395B/O	Black, 3-pin XLR
MX395AL/C, MX395AL/BI, MX395AL/O	Aluminum, 3-pin XLR
MX395W/C, MX395W/BI, MX395W/O	White, 3-pin XLR
MX395B/C-LED, MX395B/BI-LED, MX395B/O-LED	Black, 5-pin XLR, LED, bi-color status indicator
MX395AL/C-LED, MX395AL/BI-LED, MX395AL/O-LED	Aluminum, 5-pin XLR, LED, bi-color status indicator
MX395W/C-LED, MX395W/BI-LED, MX395W/O-LED	White, 5-pin XLR, LED, bi-color status indicator

Furnished Accessories

65A405	Rubber isolation rings
95A1118 (LED Models only)	5-pin XLR-female connector
65A2190	Wing nut

MX395 LOW PROFILE BOUNDARY MICROPHONES

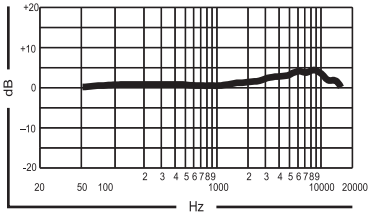
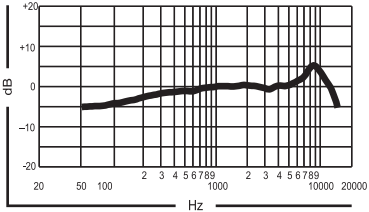
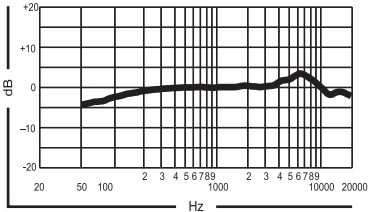
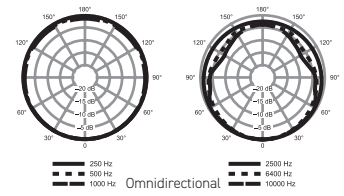
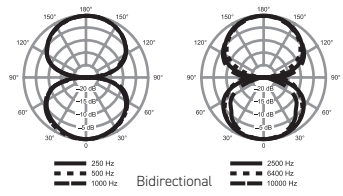
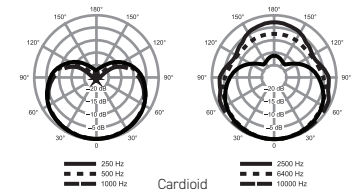

MX202 OVERHEAD MICROPHONES

Easily hung from ceilings, Microflex Overhead Microphones capture sound from speakers, choirs, stages, and more conveniently and unobtrusively from above. Compact and flexible, overhead microphones each feature a 10 cm (4") gooseneck, multiple preamp options for easy installation into ceilings or microphone stands, and versatile condenser cartridges for accurate sound reproduction in any setting.

Specifications

Type	Condenser (electret bias)
Frequency Response	50 Hz – 17 kHz
Polar Pattern	MX202/C: Cardioid MX202/O: Omnidirectional MX202/S: Supercardioid MX202/MS Lobar mini-shotgun
Output Impedance	150 Ω rated at EIA (180 Ω actual)
Sensitivity (at 1 kHz, open circuit voltage; 1 Pascal = 94 dB SPL)	Cardioid: -35.0 dBV/Pa (17.8 mV) Supercardioid: -33.5 dBV/Pa (21.1 mV) Omnidirectional: -27.5 dBV/Pa (42.2 mV) Lobar: -33 dBV/Pa (22 mV)a
Maximum SPL (1 kHz at 1% THD, 1 kΩ load; All values +6 dB at 0 gain)	Cardioid: 124.2 dB Supercardioid: 122.7 dB Omnidirectional: 116.7 dB Lobar: 121 dB SPL
Equivalent Output Noise A-weighted	Cardioid: 28.0 dB SPL Supercardioid: 26.5 dB SPL Omnidirectional: 20.5 dB SPL Lobar: 36 dB
Signal to Noise Ratio (referenced at 94 dB SPL)	Cardioid: 66.0 dB Supercardioid: 67.5 dB Omnidirectional: 73.5 dB Lobar: 68 dB
Dynamic Range 1 kΩ load at 1 kHz	96.2 dB 100 dB at 0 gain (internal modification)
Common Mode Rejection 10 Hz to 100 kHz	45 dB minimum
Preamplifier Output Clipping Level 1% THD	-6 dBV (0.5 V)
Polarity	Positive sound pressure on diaphragm produces positive voltage on pin 2 relative to pin 3 of output connector.
Power Requirements	11 – 52 Vdc phantom, 2.0 mA
Environmental Requirements	Operating temperature range: -18° C – 57° C Relative humidity: 0 – 95%
Cable Length	30 feet (9.1 m)
Termination	TA4F 4-socket female (in-line preamp models); bare ends (plate-mounted preamp models)

Available Models

The polar pattern of the cartridge is indicated by the model number suffix: C = Cardioid, S = Supercardioid, N = No Cartridge, MS = Lobar

MX202B/C, /S, /N, /MS	Black mini-condenser microphone; includes cable, in-line preamplifier, and stand adapter
MX202W-A/C, /S, /N, /MS	Bright white mini-condenser microphone; includes cable, in-line preamplifier, and stand adapter
MX202BP/C, /S, /N, /MS	Black mini-condenser microphone; includes cable and plate-mounted preamplifier
MX202WP-A/C, /S, /N, /MS	Bright white mini-condenser microphone; includes cable and plate-mounted preamplifier

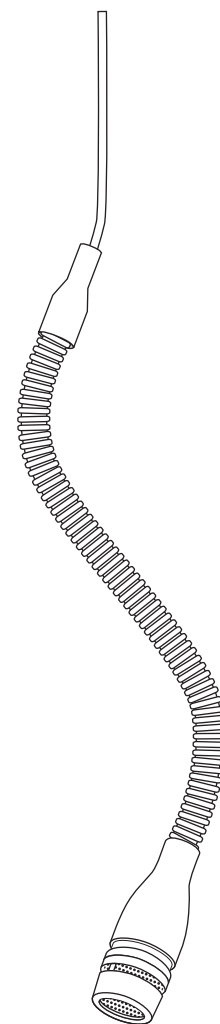

MX202
Overhead Microphone

MX202 OVERHEAD MICROPHONES

Furnished Accessories

RK183WS (Black) 95B2064 (White)	Black snap-fit foam windscreen White snap-fit foam windscreen	65B1752	Stand adapter (MX202B)
RK202PK	Preamplifier kit, plate mounted, White (MX202BP & MX202WP)	RK100PK/ RK100PKW	In-line preamplifier (MX202W & MX202B)
80A476	Clamp (MX202B & MX202WP)	80B489	Hang clip
A189BWS	Black snap fit windscreen for R189	A189WWS	Bright white snap fit windscreen for R189

Optional Accessories and Replacement Parts

A202BB	Desk stand	R184B (Black) R184W-A (White)	Supercardioid cartridge for all Microflex models
80A479	Strain relief (MX202BP & MX202WP)	R185B (Black) R185-A (White)	Cardioid cartridge for all Microflex models
R189B	(Black) mini-shotgun cartridge for all Microflex Models	R189W	(White) mini-shotgun cartridge for all Microflex Models
R183B (Black) R183W-A (White)	Omnidirectional cartridge for all Microflex models		

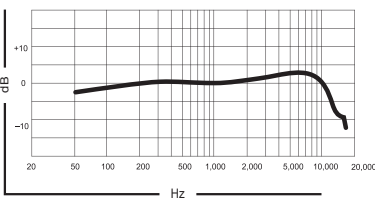
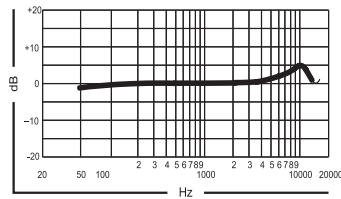
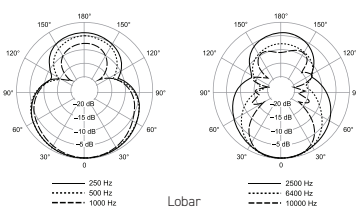
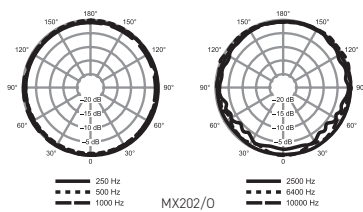
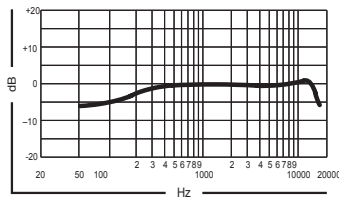
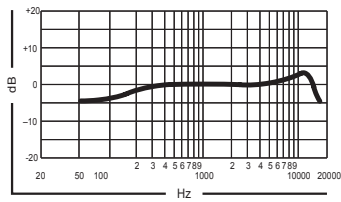
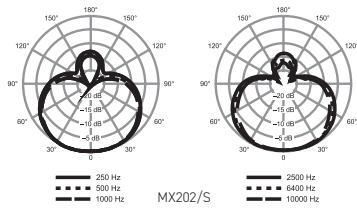
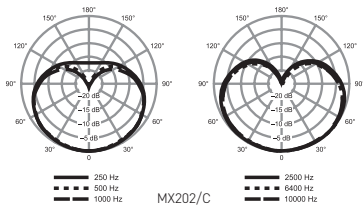

MX391, MX392, MX393 BOUNDARY MICROPHONES

With slim design and superior audio reproduction, Microflex Boundary Microphones are the ideal conference room solution. Equipped with features like programmable, silent membrane switches, interchangeable cartridges, logic inputs and outputs, and LED indicators, Microflex Boundary microphones provide high-quality sound for a wide range of applications.

Specifications

Type	Condenser (electret bias)	
Frequency Response	50 Hz – 17 kHz	
Polar Pattern	MX391/C, MX392/C, MX392BE/C, MX393/C: Cardioid MX391/S, MX392BE/S, MX392/S, MX393/S: Supercardioid MX391/O, MX392/O, MX392BE/O, MX393/O: Omnidirectional	
Output Impedance	EIA rated at 150 Ω (180 Ω actual)	
Logic Connections (MX392 Only)	LED IN: Active low (≤ 1.0 V), TTL compatible. Absolute maximum voltage: -0.7 V to 50 V. SWITCH OUT: Active low (≤ 0.5 V), sinks up to 20 mA, TTL compatible. Absolute maximum voltage: -0.7 V to 50 V (up to 50 V through 3 kΩ).	
Environmental Conditions	Operating temperature range: -18° C – 57° C Relative Humidity: 0 – 95%	
Power Requirements	11 – 52 Vdc phantom, 2.0 mA	
	MX391	MX392/MX393
Sensitivity (at 1 kHz, open circuit voltage; 1 Pascal = 94 dB SPL); All settings -12 dB at 0 gain (internal modification)	Cardioid -29.5 dB (33.5 mV) Supercardioid -28.3 dB (38.5 mV) Omnidirectional -21.8 dB (81.4 mV)	Cardioid: -27.5 dBV/Pa (42.2 mV) Supercardioid: -26.5 dBV/Pa (47.3 mV) Omnidirectional: -22.0 dBV/Pa (79.4 mV)
Maximum SPL 1 kHz at 1% THD, 1 kΩ load; All settings +6 dB at 0 gain (internal modification)	Cardioid: 118.8 dB Supercardioid: 117.5 dB Omnidirectional: 110.7 dB	Cardioid: 117.0 dB Supercardioid: 116.0 dB Omnidirectional: 111.5 dB
Equivalent Output Noise A-weighted	Cardioid: 22.6 dB SPL Supercardioid: 21.3 dB SPL Omnidirectional: 14.5 dB SPL	Cardioid: 23.0 dB Supercardioid: 22.0 dB Omnidirectional: 17.5 dB
Signal-to-Noise Ratio referenced at 94 dB SPL at 1 kHz	Cardioid: 71.4 dB Supercardioid: 72.7 dB Omnidirectional: 79.5 dB	Cardioid: 71.0 dB Supercardioid: 72.0 dB Omnidirectional: 76.5 dB
Dynamic Range 1 kΩ load at 1 kHz	96.2 dB	94.0 dB
Common Mode Rejection 10 Hz to 100 kHz	45 dB minimum, 10 Hz to 100 kHz	45 dB minimum, 10 Hz to 100 kHz
Preamplifier Output Clipping Level 1% THD	-6 dBV (0.5 V)	-6 dBV (0.5 V)
Polarity	Positive sound pressure on diaphragm produces positive voltage on pin 2 relative to pin 3 of the preamplifier XLR output	Positive sound pressure on diaphragm produces positive voltage on pin 2 relative to pin 3 of output connector (MX393) or red wire relative to black wire (MX392).

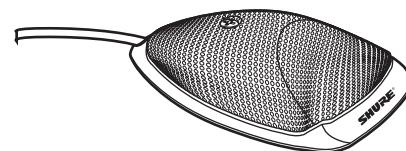

MX391
Boundary Microphone



MX393
Boundary Microphone with LED and switch

Available Models

The polar pattern of the cartridge is indicated by the model number suffix: C = Cardioid, O = Omnidirectional, S = Supercardioid

MX391/C, MX391/S, MX391/O	Black surface-mount microphone, attached 3.7 m cable terminated, 4-pin mini connector, separate preamplifier
MX391W-A/C, /S, /O	Bright white surface-mount microphone, attached 3.7 m cable terminated, 4-pin mini connector, separate preamplifier
MX392/C, MX392/S, MX392/O	Surface-mount microphone, programmable membrane on/off switch, logic input/output terminals, on/off indicator LED, screw terminal connections, attached 3.7 m unterminated cable, rear exit
MX393/C, MX393/S, MX393/O	Surface-mount microphone, programmable membrane on/off switch, on/off indicator LED, miniature three pin connector, and detachable 3.7 m cable.
MX392BE/C, MX392BE/S, MX392BE/O	Surface-mount microphone, programmable membrane on/off switch, logic input/output terminals, on/off indicator LED, screw terminal connections, attached 3.7m unterminated cable, bottom exit

MX391, MX392, MX393 BOUNDARY MICROPHONES

Furnished Accessories

95B2313	Zipper bag	80A541	Switch paint mask (MX392/MX393)
80C514	Paint mask (MX392/MX393)	36A664	Paint plug (MX392/MX393)
RK100PK	In-line preamp (MX391/MX391W)		

Optional Accessories and Replacement Parts

R183B	Omnidirectional cartridge for all Microflex models	C129	3,7 m cable 3-pin miniature connector (TA3F) to male XLR (MX393)
R184B	Supercardioid cartridge for all Microflex models	C130	Custom logic cable with threaded adapter
R185B	Cardioid cartridge for all Microflex models	15A525	Custom logic cable (specify length)

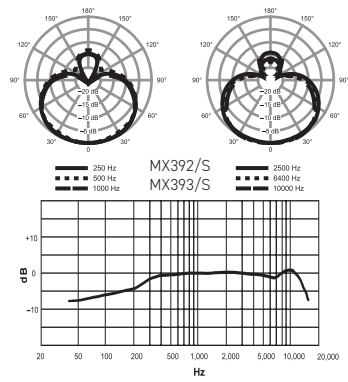
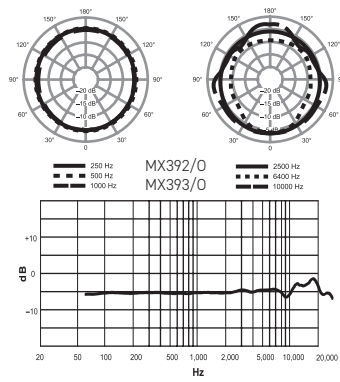
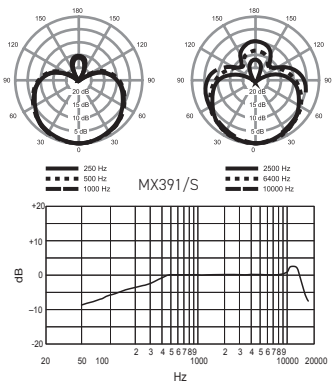
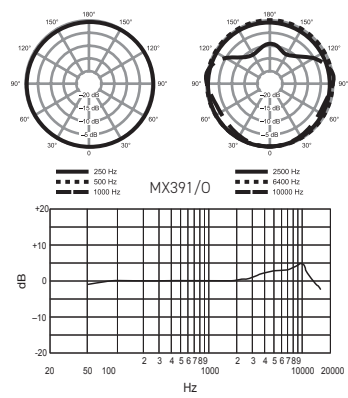
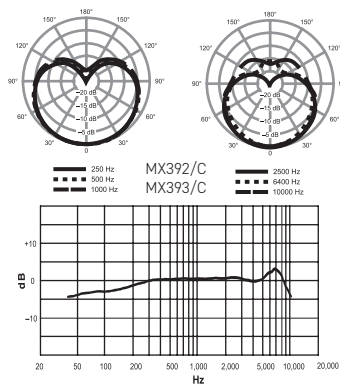
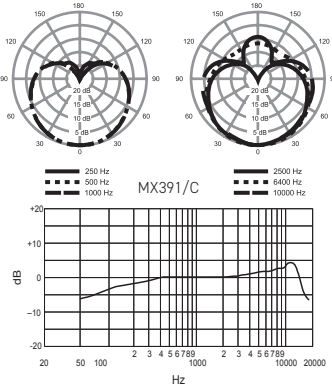

MX150 SUBMINIATURE CONDENSER LAVALIER MICROPHONE

The Shure Microflex MX150 is a professional subminiature electret condenser lavalier microphone ideal for use in speech and other applications requiring low profile, discreet placement. Available with cardioid or omnidirectional patterns, the MX150 provides uncompromised sound quality and high reliability with minimal visibility for use in television broadcasting, corporate and educational lectures, A/V teleconferencing, and sound reinforcement.

Features

- Available in cardioid or omnidirectional polar patterns and TQG/TA4F (for use in Shure bodypacks) or wired XLR variations
- CommShield® technology guards against interference from cellular RF devices and digital bodypack transmitters
- Matte black, sleek, low-profile, design for inconspicuous placement
- Multi-position tie clip allows for a variety of placement options and features an integrated cable management system for convenient cable dress with minimized handling noise.
- Kevlar-reinforced soft-flex cable design further reduces handling noise while providing superior flexibility for routing and placement
- User-changeable equalization caps for response shaping (omnidirectional only)
- Snap-fit, concise windscreen provides protection from plosives and wind noise with minimal visibility
- Legendary Shure quality, ruggedness, and reliability

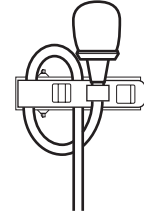

MX150 with tie clip and windscreen

Available Models

MX150B/O-TQG	Microflex subminiature condenser lavalier microphone, omnidirectional, TQG connector
MX150B/C-TQG	Microflex subminiature condenser lavalier microphone, cardioid, TQG connector
MX150B/O-XLR	Microflex subminiature condenser lavalier microphone, omnidirectional, XLR connector
MX150B/C-XLR	Microflex subminiature condenser lavalier microphone, cardioid, XLR connector

Specifications

	MX150/C	MX150/O
Transducer Type	Electret condenser	Electret condenser
Polar Pattern	Cardioid	Omnidirectional
Frequency Response	20 – 20 kHz	20 – 20 kHz
Output Impedance	TQG: N/A, XLR: 165.5 Ω	TQG: N/A, XLR: 165.0 Ω
Sensitivity open circuit voltage, @ 1 kHz, typical	TQG: -51.0 dBV/Pa (3.0 mV) XLR: -39.0 dBV/Pa (11.0 mV)	TQG: -46.5 dBV/Pa (4.5 mV) XLR: -34.5 dBV/Pa (19.0 mV)
Maximum SPL 1 kHz at 1% THD, 2500 Ω Load	TQG: 147.5 dB SPL XLR: 134.5 dB SPL	TQG: 143.0 dB SPL XLR: 130 dB SPL
Signal-to-Noise Ratio	TQG: 57.5 dB XLR: 57.0 dB	TQG: 60.0 dB XLR: 59.5 dB
Clipping Level 1 kHz at 1% THD, 2500 Ω Load	TQG: 2.0 dBV XLR: 1.0 dBV	TQG: 2.0 dBV XLR: 1.0 dBV
Common Mode Rejection 20 Hz – 20 kHz	TQG: N/A XLR: >60 dB	TQG: N/A XLR: >60 dB
Dynamic Range @ 1 kHz, 2500 Ω Load	TQG: 111.0 dB SPL XLR: 97.5 dB SPL	TQG: 109.0 dB SPL XLR: 95.5 dB SPL
Self Noise equivalent SPL, A-weighted, typical	TQG: 36.5 dB XLR: 37.0 dB	TQG: 34.0 dB XLR: 34.5 dB
Operating Temperature Range	-18°C to 57°C	-18°C to 57°C
Polarity	TQG: Positive pressure on diaphragm produces positive voltage on pin 3 with respect to pin 1 XLR: Positive pressure on diaphragm produces positive voltage on pin 2 with respect to pin 3	
Power Requirements	TQG: 5 V DC (0.04 – 0.18 mA) XLR: 11-52 V DC phantom power (IEC-61938), < 2.2 mA	TQG: 5 V DC (0.04 – 0.18 mA) XLR: 11-52 V DC phantom power (IEC-61938), < 2.2 mA
Cable Length	1.52 m	1.52 m
Weight	TQG: 21 g XLR: 121 g	TQG: 21 g XLR: 121 g

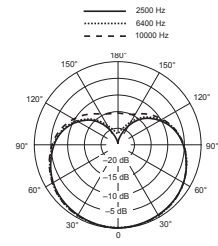
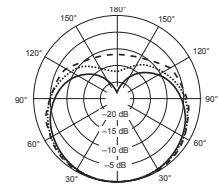

MX150/C Polar Pattern

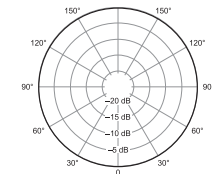

MX150/O Polar Pattern

Accessories

WA150	Storage pouch for MX150
WA330	TQG/TA4F 4 pin connector
RK100PK	XLR preamp

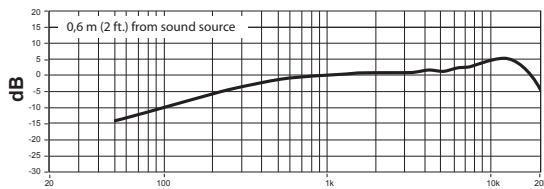

MX150/C Frequency Response

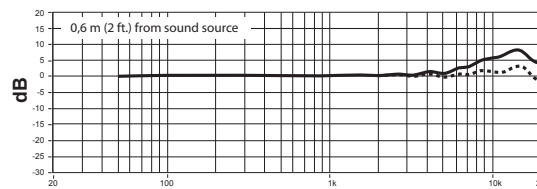

MX150/O Frequency Response

Boost Cap
Normal Cap



MX153 EARSET HEADWORN MICROPHONE

The Shure Microflex MX153 is a professional subminiature earset microphone ideal for speech and other applications requiring low-profile discreet placement where improved gain before feedback over lavalier microphones is desired. Delivering exceptional speech clarity, the MX153 is ideal for corporate and educational presentations, A/V conferencing and live sound reinforcement. Available in three color options and direct TA4F connectivity to Shure bodypacks, the MX153 provides outstanding clarity in an extremely comfortable, over the ear design.

Features

- Subminiature, omnidirectional cartridge offers superior speech clarity and enhanced plosive protection with no proximity effect
- Terminated with TQG/TA4F connector for direct connectivity to Shure wireless bodypack transmitters
- Ultra-lightweight, comfortable, flexible design is stable and easy to place over either ear
- CommShield™ technology guards against interference from cellular RF devices and digital bodypack transmitters
- Kevlar reinforced, attached soft-flex cable
- Matte black, tan, and cocoa color options available
- Includes protective storage pouch, 3 windscreens, and collar clip

Available Models

MX153B/O-TQG	Microflex earset headworn condenser microphone, omnidirectional, TQG connector, black
MX153T/O-TQG	Microflex earset headworn condenser microphone, omnidirectional, TQG connector, tan
MX153C/O-TQG	Microflex earset headworn condenser microphone, omnidirectional, TQG connector, cocoa

Specifications

	MX153
Transducer Type	Electret condenser
Polar Pattern	Omnidirectional
Frequency Response	20 Hz – 20 kHz
Output Impedance	N/A
Sensitivity open circuit voltage, @ 1 kHz, typical	-41 dBV/Pa (9 mV)
Maximum SPL 1 kHz at 1% THD	2500 Ω load: 107 dB SPL 1000 Ω load: 107 dB SPL
Signal-to-Noise Ratio	60 dB
Dynamic Range @ 1 kHz	2500 Ω load: 73 dB 1000 Ω load: 73 dB
Common Mode Rejection 20 Hz – 20 kHz	N/A
Self Noise equivalent SPL, A-weighted, typical	34 dB
Operating Temperature Range	-18°C – 57°C
Polarity	Positive pressure on diaphragm produces negative voltage on pin 3 with respect to pin 1
Power Requirements	+1-5 V DC (500 µA maximum)
Weight	19.8 g

Accessories

WA150	Storage pouch for MX150
WA330	TQG/TA4F 4 pin connector
RK100PK	XLR preamp

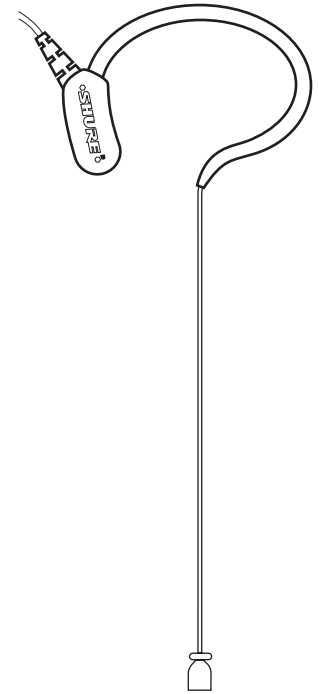
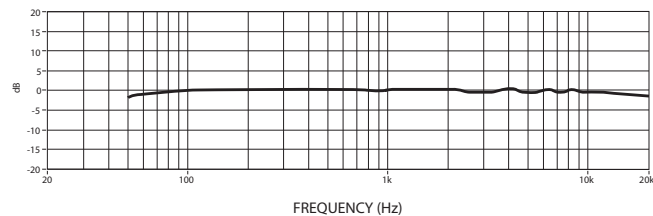

MX153 Earset
Headworn Microphone

MX183, MX184, MX185 LAVALIER MICROPHONES

Attached to a tie or lapel, Microflex Lavalier Microphones offer freedom of movement to any situation involving voice reproduction. As stylish as they are convenient, Lavaliers are available in different directional patterns, come with multiple clip options, and are compatible with all Shure wireless platforms.

Specifications

Type	Condenser (electret bias)
Frequency Response	50 Hz – 17 kHz
Polar Pattern	MX183: Omnidirectional MX184: Supercardioid MX185: Cardioid
Output Impedance	EIA rated at 150 Ω (170 Ω actual)
Sensitivity (at 1 kHz, open circuit voltage; 1 Pascal = 94 dB SPL; all settings -12 dB at 0 gain)	MX183: -27.5 dB (42.2 mV) MX184: -33.5 dB (21.1 mV) MX185: -35.4 dB (17.0 mV)
Maximum SPL (1 kHz at 1% THD, 1 k Ω load; all settings +6 dB at 0 gain)	MX183: 116.7 dB MX184: 122.7 dB MX185: 124.2 dB
Equivalent Output Noise A-weighted	MX183: 20.5 dB MX184: 26.5 dB MX185: 28.0 dB
Signal-to-Noise Ratio referenced at 94 dB SPL at 1 kHz	MX183: 73.5 dB MX184: 67.5 dB MX185: 66.0 dB
Dynamic Range 1 k Ω load at 1 kHz	96.2 dB 100 dB at 0 gain (internal modification)
Common Mode Rejection 10 Hz to 100 kHz	45 dB minimum
Polarity	Positive sound pressure on diaphragm produces positive voltage on pin 2 relative to pin 3 of output XLR connector.
Environmental Conditions	Operating temperature range: -18° - 57° C Storage temperature range: -29° - 74° C
Power Requirements	11 – 52 Vdc phantom, 2.0 mA
Cable	Shielded 1.2 m cable terminated with a 4-pin female mini connector (TA4F)

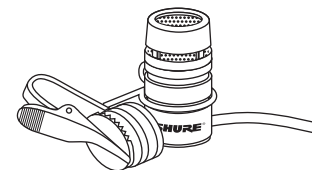

MX183/ MX184/ MX185
Lavalier microphone

Available Models

MX183	Omnidirectional, includes belt-clip preamp, rotatable tie clip, dual tie clip, snap-fit windscreen
MX184	Supercardioid, includes belt-clip preamp, rotatable tie clip, dual tie clip, snap-fit windscreen
MX185	Cardioid, includes belt-clip preamp, rotatable tie clip, dual tie clip, snap-fit windscreen

MX183, MX184, MX185 LAVALIER MICROPHONES

Furnished Accessories

26A13	Zipper bag	RK183T1	Tie clip
RK261BWS	Foam windscreen	RK183T2	Dual tie clip
RK183WS	Snap-fit windscreen	RK100PK	In-line preamp
80A67	Hex wrench #4		

Optional Accessories and Replacement Parts

R183B	(Black) Omnidirectional cartridge for all Microflex models	R184B	(Black) Supercardioid cartridge for all Microflex models
R185B	(Black) Cardioid cartridge for all Microflex models	MX1BP	Battery powered preamp
53A2133A	Belt clip for in-line preamp	WA333	4-pin female mini connector (TA4F)
C133	Replacement cable, Microphone to preamp		

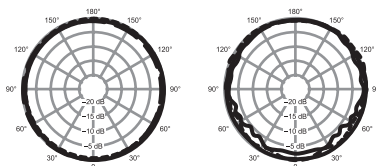

MX183

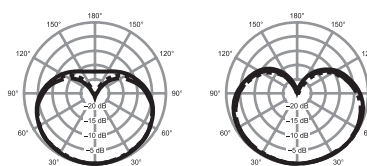

MX185

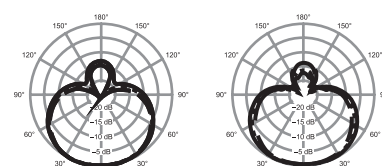

MX184

